



# ULTIMHEAT

## HEAT & CONTROLS



# ELECTROMECHANICAL & ELECTRONIC THERMOSTATS FOR INCORPORATION

- For these thermostats incorporated inside various boxes, housing & cabinets:
- Explosion proof versions:

See catalogues N°2 & 3

See catalogue N°4

Contact us









Because of permanent improvement of our products, drawings, descriptions, features used on these data sheets are for guidance only and can be modified without prior advice

|          |                         |        |
|----------|-------------------------|--------|
| Setion 1 | Summary                 | P1 - 4 |
| Setion 2 | Historical introduction | P1-P4  |
|          | Technical introduction  | P5-P40 |
| Setion3  | References list         | P1-P4  |

| Temperature control thermostats   |   |   |  |  | P1-P24  |
|---|---|---|--|--|---------|
| Section 4   |    |  | Type 4911  | Snap action bimetal disc thermostat, 1/2" disc, reduced 6 mm thickness, 10A 250V.      | P3-P4   |
|   |    |  | Type 4903  | Snap action bimetal disc thermostat, 1/2" disc, 12mm thickness, 16A 250V.              | P5-P6   |
|   |    |  | Various models   | Setion of antifreeze or defrost applicaton disc thermostat.                            | P7-P8   |
|   |    |   | Type 49JE  | Technical over-molding of thermostats.   | P9      |
|   |    |   | Type IB  | Surface sensing bimetal thermostat.  | P10     |
|   |   |   | Type 35ER  | Energy regulators.   | P11     |
|   |  |   | Type 8G  | 16A Single pole control thermostat (Appliances type).                                  | P12-P14 |
|   |  |   | Type 8GB100500   | Bulb and capillary thermostat, temperature range 100-500°C.                            | P15     |
|   |  |   | Type KQA and KTA   | Single pole control thermostat, standard and reduced differential.                     | P16     |
|   |  |   | Type KO-V  | Din rail mounting bulb and capillary thermostat. Downside electrical connection block. | P17     |
|   |  |   | Type 8C  | 3 x 16A control thermostat.  | P18-P19 |
|   |  |   | Type SR and SU   | 15A Single pole rod thermostat.  | P20     |
|   |  |   | Type VR and VU   | 15A Single pole rod thermostat with dead zone.   | P21     |
|  |   | Type WQD  | Wood and solid fuel stove damper bulb and capillary thermostat . | P22-P23  |         |











| Electronic thermostats |   |             |  | P1 - 8 |
|------------------------|---|-------------|--|--------|
| Section 5              |  | Type 2PE2N6 | Blind electronic thermostat, 16A, temperature control or manual reset limiter  | P3     |
|                        |  | Type 2PE2P6 | Electronic thermostat, knob adjustment, remote sensor, Pt100 temperature sensor, temperature control or manual reset limiter | P4     |
|                        |  | Type 2DNAP6 | Digital display electronic thermostat, 16A.  | P5-P6  |
|                        |  | Accessoires | Accessories for 2PE2N6 and 2PE2P6.   | P7-P8  |

| Manual reset and thermal cut out |   |             |   | P1-P14  |
|----------------------------------|---|-------------|---|---------|
| Section 6                        |    | Type 4R05   | Manual reset snap action bimetal disc thermostat, 1/2" disc.                | P3-P4   |
|                                  |   | Type 4REMR  | Epoxy potted waterproof manual reset disc thermostat, 2 wire output.        | P5      |
|                                  |  | Type 4C     | 3 poles manual reset disc thermostat.                                       | P6      |
|                                  |  | Type KZ-3   | Manual reset high limit thermostat, fail safe, calibration from 20 to 500°C | P7      |
|                                  |  | Type 8L     | SPNC manual reset high limit, fail safe.                                    | P8      |
|                                  |  | Type 8X     | DPNC manual reset high limit, fail safe.                                    | P9      |
|                                  |  | Type 82     | 3 poles manual reset high limit, fail safe.                                 | P10     |
|                                  |  | Type 85     | 3 poles manual reset high limit, fail safe                                  | P11-P12 |
|                                  |  | Type 5MA3   | Thermal cut out, 10 and 16A 250V, in line.                                  | P13-P14 |
|                                  |  | Type 5MA3-F | Wired thermal cut out, 16A250V, for pocket mounting.                        | P15     |

Because of permanent improvement of our products, drawings, descriptions, features used on these data sheets are for guidance only and can be modified without prior advice



Because of permanent improvement of our products, drawings, descriptions, features used on these data sheets are for guidance only and can be modified without prior advice

| Thermostat accessories |   | P1 - 12  |
|------------------------|---|--|
| Section 7              |    | Thermostats knobs.<br>P3 - 4                                   |
|                        |    | Bezels, dials and plates.<br>P5                                |
|                        |    | Shafts gaskets and pockets.<br>P6                              |
|                        |    | Pockets and pockets grommets.<br>P7                            |
|                        |    | Brackets, fittings and thermostats boots.<br>P8                |
|                        |    | Disc thermostats accessories<br>P8                             |
|                        |   | Thermostat shaft switches and heating elements switches.<br>P9 |
|                        |  | Connector for bulb and capillary thermostat.<br>P10            |



: These products are not made by Ultimheat



Because of permanent improvement of our products, drawings, descriptions, features used on these data sheets are for guidance only and can be modified without prior advice



# Historical introduction

Because of permanent improvement of our products, drawings, descriptions, features used on these data sheets are for guidance only and can be modified without prior advice



Because of permanent improvement of our products, drawings, descriptions, features used on these data sheets are for guidance only and can be modified without prior advice





*Thermostats arose with the need to maintain a constant temperature in alchemist ovens and incubators, and to save fuelwood, then followed, using various techniques, the development of the use of charcoal, lighting gas, electricity, and petroleum-derived liquid fuels.*

*Their mechanisms were diversified according to the needs of the devices: incubators, stoves, industrial and domestic boilers, central heating systems, water heaters, radiators and gas and electric fireplaces, electric and explosion motors, then all domestic cooking appliances.*

*Their operating principles and construction evolved with the emergence of new metals and alloys: invar, Beryllium or Phosphorus Bronze, Stainless Steel, Tombac. The precision of the devices followed the evolution of metal rolling and bimetal co-lamination. Gas mixtures, essential for vapor pressure thermostats, and liquids, essential for liquid expansion thermostats, followed the development of chemistry.*

*The manufacture of capillary tubes in copper and then in stainless steel, in smaller and smaller diameters, allowed the expansion of devices with remote measurement.*

*Electrical insulation, long limited to micas and micanites, improved with the arrival of thermosets: ebonite, bakelite, and polyesters, then finally the huge family of thermoplastics that were developed following the invention of nylon. The boxes and bases followed the same evolution.*

*Electrical contacts, initially dependent on bulky and oxidizable mercury pots, became more effective with mercury bulbs under nitrogen atmosphere, then with dry contacts in silver and its alloys.*

*The invention of snap-action contact mechanisms allowed use on 220 volts circuits, while providing a very long service life to all these devices.*

*Initially bulky, the mechanisms were miniaturized by following the development of micromechanics and by borrowing watchmaking techniques.*

*A corollary of miniaturization, automation, especially from the years 1975-80, caused production costs to fall.*

*While some models have disappeared, often following the decline in their applications, thermostats have proliferated in a world where safety is a priority. They are now present, although invisible, by the dozens or even hundreds, in all homes, in household appliances, in small electric motors, in heaters as well as in vehicles.*

*Thanks to their proven reliability, their high electrical breaking capacity and their (apparent) simplicity, they will remain irreplaceable, even in a world where electronics are playing an increasingly important role.*

*For more information on the history of thermostats, see "Outline of the Thermostats history", by Jacques Jumeau, 2020, published by Ultimheat, 256 pages with more than 427 illustrations, describing the history of 40 families of thermostats.*



Because of permanent improvement of our products, drawings, descriptions, features used on these data sheets are for guidance only and can be modified without prior advice



---

# Technical introduction

Because of permanent improvement of our products, drawings, descriptions, features used on these data sheets are for guidance only and can be modified without prior advice



Because of permanent improvement of our products, drawings, descriptions, features used on these data sheets are for guidance only and can be modified without prior advice



The temperature measurement was preceded by a long period, throughout the 18<sup>th</sup> century, when first empirically and then gradually more accurately, have been developed measurement scales, were discovered fixed points for the calibration of these scales, and all physical variations related to temperature change: thermal expansion of gases, liquids, metals and other solids, liquefaction temperatures, boiling temperature, magnetism, thermoelectricity, just to give a few.

However, this is only when the shortage of charcoal, the rising price of heating means added with the need for precise temperature control, that were developed thermostats. The first one was made for incubators at the end of the 18<sup>th</sup> century, by the French engineer Jean Simon Bonnemain, with the first accurate bimetallic rod thermostat in 1788 (It was named at that time "Gouverneur du feu" or "régulateur du feu" (fire governor). It was used to control the water temperature of the first central heating boiler using the thermosyphon that he also invented.

In the first quarter of the 19<sup>th</sup> century, the huge development of the central heating by hot water or low pressure steam generalized various control systems, most of them in the low pressure steam boilers, and the arrival of electricity for domestic use in the late 19<sup>th</sup> century initiated the search for and discovery during the first 50 years of the 20<sup>th</sup> century almost all current systems thermostats.

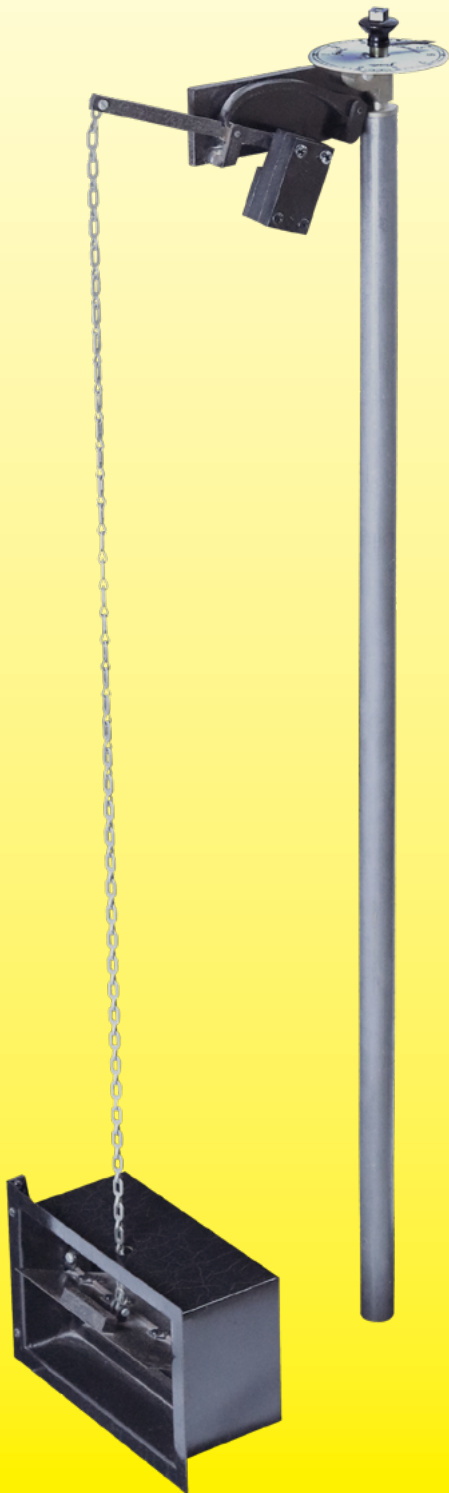

*1788. The first rod thermostat named "Régulateur du feu" invented and built by Jean Simon Bonnemain, French engineer, to control the temperature of a Hatchery in the suburbs of Paris, heated by the first thermosyphon boiler also invented for the occasion.*



## 1. Temperature sensing principles

### 1.1 Bimetals



#### 1.1.1 BIMETAL STRIPS

The bimetal strip is formed by two co-laminated metal. One has a high coefficient of expansion, the other a lower or zero. When this strip is heated, it bends proportionally to the temperature. These bimetal blades are generally flat and fixed at one end. But they can be wound in a spiral shape, although this arrangement most often used in the construction of thermometers.

#### 1.1.2 DISCS AND DISCS VARIATIONS



In many applications, it is needed to produce a bimetal with a snap operation with a sudden change of shape at a given temperature. For this, a bimetal disc is bumped and formed into a dome. Temperature changes cause an accumulation of energy therein, which, at a specified temperature, snaps from the concave to the convex shape. A very rigorous selection of the composition, thickness, depths of stamping and heat treatment, is requested to obtaining accurate, stable and repetitive operating temperature.

Based on original round form, were developed rectangular shapes, ovals, etc...

The main difficulty is to obtain a small tolerance and a small differential on operating temperature.

But these snap action discs are the sensing device of most temperature limiters on the market.



Because of permanent improvement of our products, drawings, descriptions, features used on these data sheets are for guidance only and can be modified without prior advice

## 1.2 DOUBLE METAL EXPANSION

Double metal expansion is the differential expansion of 2 different metals, not laminated together. Metal thermal expansion produces huge force, enough for example do bend railways rails when expansion gaps are not correctly designed.

### 1.2.1 CARTRIDGES

The cartridge consists of an outer expandable tube, usually stainless steel, and two non-expandable internal blades, usually Invar. The elongation of the envelope is a function of temperature. For a length of about 100mm, this expansion is 0.0020mm per °C.



### 1.2.2 PARALLEL BLADES

Their principle is similar to cartridges, they are made of one expandable copper alloy blade to which is welded at each of its ends a bow shaped invar blade. Expansion of the copper alloy blade will tend to reduce the distance between the two blades.



### 1.2.3 RODS

The rods are formed of an outer expandable tube in stainless steel, copper or brass, and an inner invar rod. Expansions value are similar as the cartridges. This principle is the basis of most current water heater thermostats. This is a very simple, very reliable, the reaction time is very fast, as it is the outer tube itself that measures the temperature. Through the use of expandable metal instead of Invar, it is possible to obtain devices with anticipative control action, which is very close to proportional action of electronic controllers. Using the same metal for the outer tube and the inner rod provides controls that are only responsive to fast changes in temperature and are used in fire detectors. In very high temperatures, invar rod can be replaced by quartz or alumina.



## 1.3 LIQUID EXPANSION

Liquids are incompressible and expand as solids. The expansion forces are very important and will develop considerable power to the mechanisms. The expansion of liquid are used in closed subassemblies named "diastats", they consist of a bulb, a capillary, a bellows or diaphragm. The expansion of the liquid in the bulb is transmitted through the capillary to the diaphragm which inflates and produces movement. Diaphragms expansion ranges are between 0.4 and 0.8mm for the entire measuring range. Bulbs volumes are calculated to provide a specific displacement for a given range. Freezing temperature of the liquid gives the lower limit of use, the upper limit is the boiling temperature. Raising these limits generally cause the destruction of the diastat. The good thermal conductivity of liquids used provides short response time.

### 1.3.1 LIQUID METALS

Mercury was the first liquid used in thermostats. Its first use was the traditional mercury thermometer. Its expansion is almost linear from ambient to 500°C. This is an excellent conductor of heat. So it was ideal for liquid thermostats. However its toxicity has done it to virtually disappear during last decade.

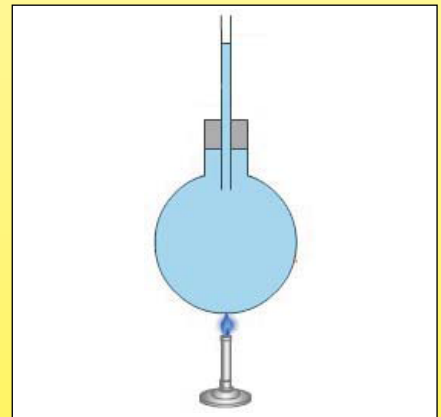



## 1.3.2 LIQUID METALLOIDS

Metalloids are on the borderline between metals and other materials. In thermostats, are only used sodium and potassium, and especially an eutectic mixture of the two, NaK, which as the interesting characteristic to be liquid in a wide range of temperature, from ambient temperature to over 900°C. It is also an excellent conductor of temperature.

These two characteristics have earned him to be selected as a coolant for nuclear plants.

For temperature measurement, it also has the advantage of having a linear expansion.

Its use in thermostats is relatively recent, and arose with self-cleaning ovens, because it allows devices withstanding high temperatures.

However, it must be used in protected devices, without contact with air or water, because it is particularly reactive, flammable or explosive in contact with them.

It is also corrosive and requires special stainless steel diastats.



## 1.3.3 OILS

Many oils are used. They are always a compromise between a high coefficient of expansion, which allows small bulbs, a boiling point as high as possible, a freezing temperature as low as possible, a good linearity in the range expansion, a good thermal conductivity, and non-toxicity.

Among the most common, we must mention the xylols, oils used in heat exchangers, and silicone oils.

It is now possible to cover with these 3 types of liquids, ranges from -40°C to 400°C.

## 1.3.4 The thermal drift (Correction factor) of liquid filled bulb and capillary thermostats

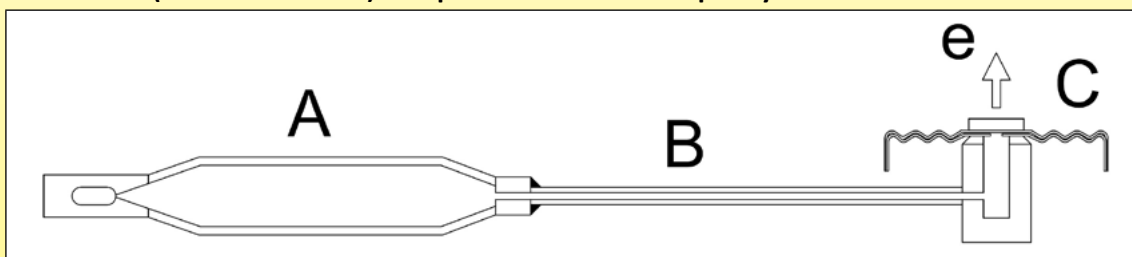

**The bulb and capillary thermostats have a closed subassembly called “Diastat”.**

**This diastat, with bulb and capillary made of copper or stainless steel, is composed of 3 parts welded together:**

1. The bulb (A), which is the reservoir of the largest portion of the liquid, and liquid expansion as a function of temperature will be used to measure it. It is closed at its free end by welding after liquid filling.
2. The capillary (B), whose outer diameter varies depending on the manufacturer and type of thermostat, between 1mm and 3mm, which serves to transmit remotely the increase in volume of the liquid in the bulb.
3. The bellows (C), consisting of two flexible cups welded together on their edges, having a diameter of 19 to 25mm (sometimes up to 32mm on industrial devices), which will convert the increase of the bulb liquid volume into mechanical displacement (e).

These three parts are filled with a liquid under vacuum. The expansion of the liquid, proportional to the temperature increase, causes the displacement “e”, which is used to operate an electrical contact.

However, the expansion of the liquid in the capillary (B) and into the bellows (C) is not related to the temperature measured by the sensor (A), but to room temperature in which they are located, and cause therefore a parasite expansion of the liquid and therefore an unwanted mechanical displacement.

The design of a diastat tends to minimize this movement, by limiting the volume of liquid in (C) and (B) by 2 ways:

- By limiting the capillary internal diameter. The minimum diameter is a compromise between the technological possibilities of embodiment of the capillaries, the stresses due to bending of the capillary, and the water pressure losses permissible depending on the viscosity of the liquid used, and the pressure developed by the expansion.
- On the bellows: when filling the diastat, the two membranes forming the bellows are pressed against each other, without gap, and thus only a small amount of fluid can go between them. However the volume of liquid in the bellows increases progressively as the liquid in the bulb (A) expands by the temperature rise. The ratio of the drift therefore not only reports to the initial volume inside the bellow, but increase with the temperatures as this volume increases with the temperature rise on the bulb.

The counterpart of this design of the bellows with a small amount of liquid when filling the diastat is that no mechanical movement is possible below this filling temperature. In assembled thermostats, adjusting the set point is not possible below this temperature at which the bellows is empty. This area below the filling temperature is called “dead zone”, and typically corresponds to an area where no temperature is printed on the thermostat knob.

The parasite drift of a bulb and capillary thermostat will be given in the data sheet and expressed in °C/°C or °K/°K.

It depends on the volume ratio between the bulb and capillary + bellows. A large volume bulb is less sensitive to drift, and a short capillary also decreases it.

**In the case of fixed temperature high limit thermostat, the small bulbs will lead to a high sensitivity to the ambient temperature on the thermostat body.**





Because of permanent improvement of our products, drawings, descriptions, features used on these data sheets are for guidance only and can be modified without prior advice

**Comparative values for thermal drift in a dia. 19mm membrane diastat, and a displacement “e” of 0.8mm for the temperature span (approximate values)**

| Temperature range | Drift with 250mm capillary (°K/ °K) | Drift with 900mm capillary (°K/ °K) | Drift with 1500mm capillary (°K/ °K) |
|-------------------|-------------------------------------|-------------------------------------|--------------------------------------|
| 4-40°C            | 0.1                                 | 0.12                                | 0.14                                 |
| 30-90°C           | 0.18                                | 0.20                                | 0.24                                 |
| 50-300°C          | 0.25                                | 0.45                                | 0.58                                 |

This drift explains that thermostats calibration temperature are given for a body ambient temperature of 23°C+/- 2°C (standard ambient condition given by EN60068-1), and usually for an immersed capillary length of 80 to 100mm.

**Examples of temperature drift on a thermostat with a 1.5 m capillary (to be added to calibration tolerances)**

| Temperature range (°C) | Set point temperature (°C) | Effective contact opening temperature if ambient on thermostat body is 0°C | Effective contact opening temperature if ambient on thermostat body is 50°C |
|------------------------|----------------------------|--|---|
| 4-40                   | 40                         | 40+3, 2  | 40-3, 8   |
| 30-90                  | 90                         | 90+5, 5  | 90-6, 5   |
| 50-300                 | 300                        | 300+13, 3  | 300-15, 7   |

## 1.4 VAPOR PRESSURE

This system involves in diastats a mix of liquid and its saturated vapor, just as in a butane bottle, where are coexisting gas and liquid.

In this closed environment, any increase in temperature results in an increase in pressure and significant volume changes.

Unfortunately gases are compressible, and even if it is possible to obtain significant movements, the available force is low. Movements are not linear, and these systems are sensitive to changes in atmospheric pressure. Among the main fillers used, there are:

### 1.4.1 FREONS

They are used because of their availability, and existing vacuum filling systems for refrigerant circuits. They also work in low temperatures.

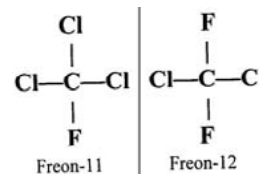
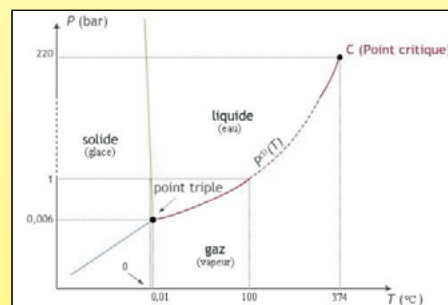

### 1.4.2 BUTANE AND PROPANE

They are used for the same reasons as above, but have the disadvantage of being flammable.



### 1.4.3 OTHERS: METHYL CHLORIDES

They are used in capillary thermostats and membranes room thermostat.

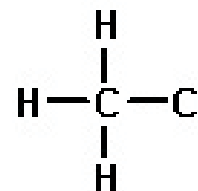



## 1.5 STATE CHANGE

In state change devices, a linear displacement against temperature is not used. What is used is the instant change of volume that appears at specific temperatures at melting, freezing, and boiling points on various elements.

For example, the freezing point of water at 0°C causes an increase in volume, melting at 0°C causes a reduction in volume, but also the transition from the solid state to the liquid state: when water is boiling at 100°C steam causes large volume increase.

State change systems will therefore use these special properties of a number of elements and compounds.

### 1.5.1 WAXES

Thermostatic wax is a complex mixture of many components providing a different Melting/Freezing temperature depending on the composition. At this temperature there occurs a high volume change. Waxes have the characteristic increase in volume when they melt.

This system, which causes a high displacement, is used for car thermostats, to open the flow path of water. It is also common in central heating radiators thermostat, as well as in mini-jacks locking the doors of ovens, washing machines and other appliances.



### 1.5.2 LOW FUSE TEMPERATURE ALLOYS

These fusible alloys are all descendants of those discovered by Darcey at the beginning of the nineteenth century. An alloy of tin, antimony, lead, bismuth and other metals, will have melting temperatures between 25 and 200°C depending of the percentage of each ingredient.

Their first applications were opening the steam pressure locomotive blowdown valve. The melting of the alloy at a predetermined temperature is used to release a mechanical system (fire fusible links) or directly open an electrical circuit (thermal cut-out electrical fuses).



### 1.5.3 BOILING

The boiling of a liquid causes, in a closed circuit, a sharp increase in pressure. This increase in pressure may be due to local boiling in a capillary thermostat diastat. This allows to make thermostats sensitive to temperature on a long distance, detecting hot spot at any place on the capillary.

Boiling is also used in glass bulbs, which breaks when the liquid inside boils and releases a mechanical or electrical system. The best-known application is the control of the "sprinkler" systems, common in building fire detection.



## 1.6 OTHER SYSTEMS

### 1.6.1 THE CURIE POINT

The Curie temperature is the temperature at which a magnet loses its magnetization. This temperature can be changed by altering the composition of the magnetic alloy. This loss of magnetization releases a mechanical or electrical system.

This application is limited to a few specific uses, such as rice cookers.



### 1.6.2 FORM MEMORY

Some alloys or compounds, subject to a certain temperature, return to the form they had before their mechanical processing. Heat treatment and composition determine these temperatures.

### 1.6.3 EXPANSION OF GAS

This system is mainly used for the production of thermometer, because the available forces are weak and can hardly operate a contact. Is linear expansion and allows a linear scale in a wide range of temperatures.

The gases used are mainly helium and argon.

These systems are sensitive to atmospheric pressure and demand a compensation system.



## 2. Electrical contacts

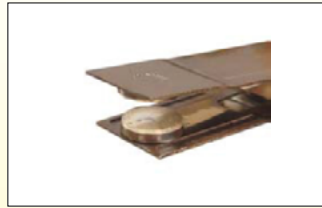

As numerous mechanisms exist, we decided not to distinguish on the basis of constructive technique, but according to their operation speed, which is the key element.

### 2.1 ELECTRICAL CONTACTS SYSTEMS

#### 2.1.1 SLOW BREAK

In slow break contacts both sides deviate slowly at speeds of the order of 1/ 10mm per second. In the normal atmosphere, then an electrical arc occurs when the contacts are close together. The duration of this arc is a function of voltage.

For voltages up to 24V DC or 110VAC, the duration of this arc is short, less than 0.1s.

For higher voltages, the arc lasts much longer, producing premature fusion of the contact, and many radio interference.

This is why it is not recommended, despite the mechanical advantages (simplicity, low cost, high precision), to use slow break (or slow make) contact in 230V electrical circuits, for fast cycling applications.



#### 2.1.2 SNAP ACTION

On snap action contacts, the gap between contacts occurs at much higher speed, of about 1m per second (100, 000 times faster than a slow break contact). The contacts spacing to extinguish the electrical arc is reached in less than 1/ 1000 sec. There is no radio interference, and the contact does not substantially deteriorate.

This type of contact is mechanically much more complicated, more expensive, and does not allow small differential control. It is particularly suitable for control devices in 240V or 400V. Several techniques are used to get a snap action:

- The oldest is the use of magnets on the contact blades. The magnetic field decreases with the 4<sup>th</sup> power of distance. The attraction between the two blades thus takes a very short distance. This system is highly reliable, but not currently used due to the large number of components that it requests.

It was used extensively on the needle contacts on barometers, manometers, thermometers with a circular dial, and was the first snap action system to be used in thermostats

- The most common today is the energy storage blade, whose drawings have been simplified in recent years, largely due to the improvement of beryllium copper alloys, and new design concepts.





## 2.2 CONSTRUCTION

### 2.2.1 MATERIAL CONTACT

Before the development of silver electrical contacts, the first electric thermostats used mercury. Liquid mercury, enclosed in a glass bulb having two electrodes, established the contact between them by tilting, or more simply, a metal needle, by its movement, established the contact with the surface of the mercury.

Electrical contacts are currently rivets made of pure silver, or slightly alloyed with other metals or oxides (Cadmium, Nickel, Tin).

Silver was chosen because it is the best known conductor of heat and electricity. Contact wears by micro vaporization at each open and close cycle. This vaporization is proportional to the strength and duration of the electric arc.

The thermal conductivity of the silver allows it to quickly evacuate the peak temperature occurring during opening of the contacts.

Its very good electrical conductivity allows for devices with very low contact resistance, generally less than 3 milliohms.

However it is not stainless and is gradually covered by a thin layer of silver oxide which is not electrically conductive. This layer is easily vaporized during use in common household voltages (120V, 230V). However, for use in low voltage (less than 12V) and very low currents (a few milliamperes), the arc created when opening the contact is not sufficient to vaporize the contact.

This is the reason why, for low-power circuits, the contacts are protected against the oxidation by a thin layer of gold.

### 2.2.2 CONTACT GAP

After opening, the contacts are spaced by a gap. This gap, according to the device may vary from  $1/10^{\text{th}}$  to 3mm or more. An usual value in thermostats is 0.3 to 0.4mm, which corresponds to micro-disconnection requested by electrical standards.

Smaller gap, which is the mechanical requirement to make low differential devices (see definition belows) cannot be used in high voltages, because, although there is no mechanical contact between the 2 contacts, an electrical arc can spontaneously appears in 380 or higher voltages: just adverse weather conditions such as high relative humidity may be sufficient.

A method to increase the contacts gap without requiring thermostats to provide significant movement, is the double break, used on some manual reset thermostats, which also reduces the risk of contact welding.

## 2.3 CONDITIONS OF USE AND ELECTRICAL LIFE

In the specifications for an electromechanical thermostat, the expected life is described in terms of mechanical and electrical.

### Electrical life:

This is specified as a minimum number of cycles (action of opening and closing) will make, carry, and break the specified load without contact sticking or welding, and without exceeding the electrical specifications of the device.

### Mechanical life:

This is the number of operations which a thermostat can be expected to perform while maintaining mechanical integrity. Mechanical life is normally tested with no load or voltage applied to the power contacts, and is not part of this document.

Switch performance is influenced by a variety of factors, including: frequency of operation, type of load, temperature, humidity, altitude. Electrical ratings are been tentatively standardized in UL 1054, CSA22.55 or IEC61058-1 (Switches for appliances). IEC60730-x standards have specified testing methods and preferred electrical life classes for electrical control and safety switches. These life classes are (cycles): 300 000, 200 000, 100 000, 30 000, 20 000, 10 000, 6 000, 3 000 (1), 1000(1), 300 (2), 30(2)(4), 1(3).

- 1) Not applicable to thermostats or to other fast cycling actions.
- 2) Applicable only to manual reset.
- 3) Applicable only to actions which require the replacement of a part after each operation.
- 4) Can only be reset during manufacturer servicing.

The rating tables should be considered as working maximum for most applications. Hereunder are given some limitations that apply when they are used in other loads and voltages.

The current rating of thermostat switches is given in their technical data sheets for a resistive load in 250 or (and) 400V AC and a specified number of operations. When there is enough room, these values are printed on the product. In most of case, only the minimum mandatory information is printed. The cycle number is exceptionally printed, but this is one of the most critical parameter to estimate the expected life of the thermostat.



### 2.3.1 Explanation of printed values made on a thermostat upon IEC60-730-1 § 7-2

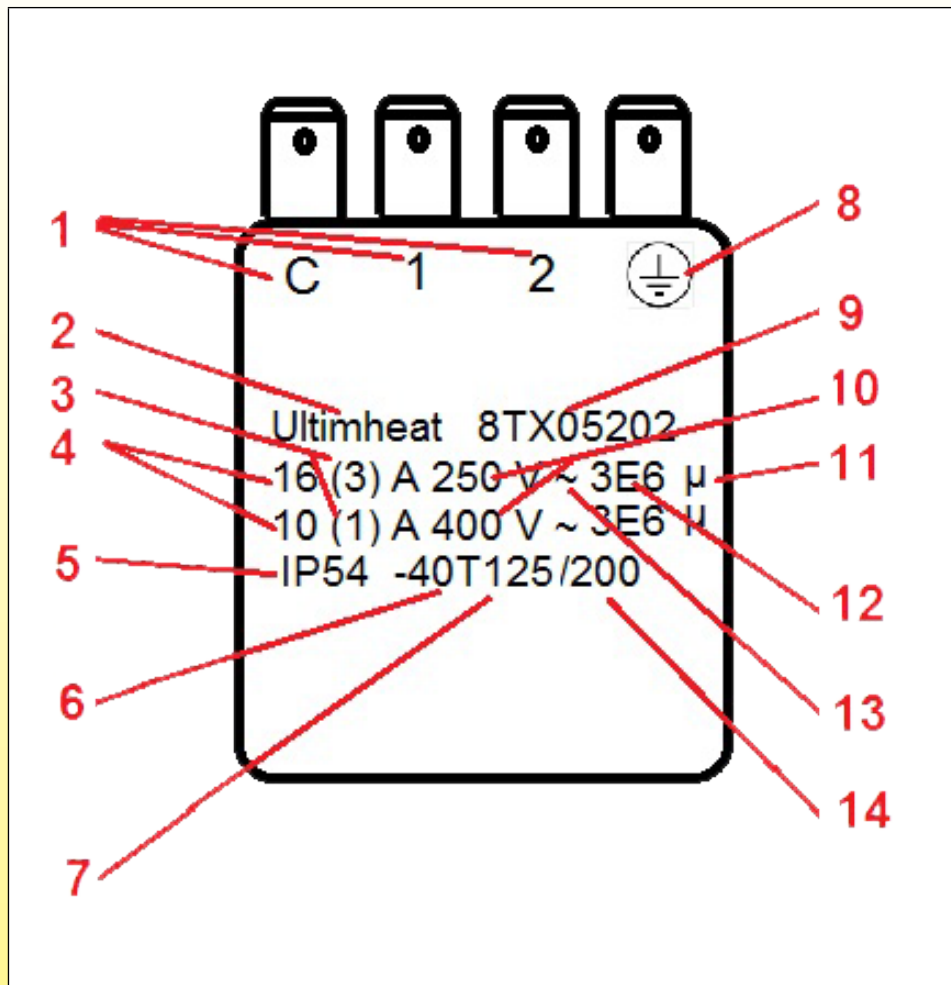

1: identification of terminals that are suitable for the connection of external conductors, and if they are suitable for line or neutral conductors, or both.

L= must be used for line in United Kingdom, other countries no restriction. N must be used if the terminals must be used for neutral ( All countries).

2: manufacturer's name or trade mark.

3: inductive load rating with power factor = 0.6 (When inductive load value is not printed, these contacts may be used for an inductive load, provided that the power factor is not less than 0, 8, and the inductive load does not exceed 60% of the current rating provided for the resistive load).

4: resistive load rating with power factor = 0.95+/- 0.05.

5: degree of protection provided by enclosure, does not apply to controls or parts thereof classified as IP00, IP10, IP20, IP30 and IP40.

6: high temperature limits of the switch head (Tmax), if other than 55°C.

7: low temperature limits of the switch head, if lower than 0°C.

8: ground terminal identification (if existing).

9: unique type reference.

10: rated voltage or rated voltage range in volts (V) (Frequency printing is mandatory if other than for range 50 Hz to 60 Hz inclusive).

11: micro-disconnection (reduced contact gap) Printing is not mandatory.

12: number of cycles of actuation for each manual action (For manual reset thermostat).

Number of automatic cycles for each automatic action (for control thermostat). Printing is not mandatory.

13: for use on alternative circuit, 50 to 60Hz inclusive.

14: temperature limits of mounting surfaces (Ts) if more than 20 K above Tmax.

### 2.3.2 VOLTAGE, RESISTIVE OR INDUCTIVE CIRCUIT, SHIFTING ANGLE (cos phi)

In Europe, the most common voltage is 230 Volts AC 50Hz. In general, all devices are designed for these conditions.

400V operation must match particular contact spacing. However, particular attention must be given to the type of load to control: electrical ratings are always given for a resistive load (cos phi = 1). Applications with inductive loads like motors, transformers, coils, ballast, or capacitive loads, like capacitors on one or 2 speed motors cause much more important electrical arcing between contacts. These inductive or capacitive loads severely limit the contact rating.



## Electrical contact rating reduction on inductive loads

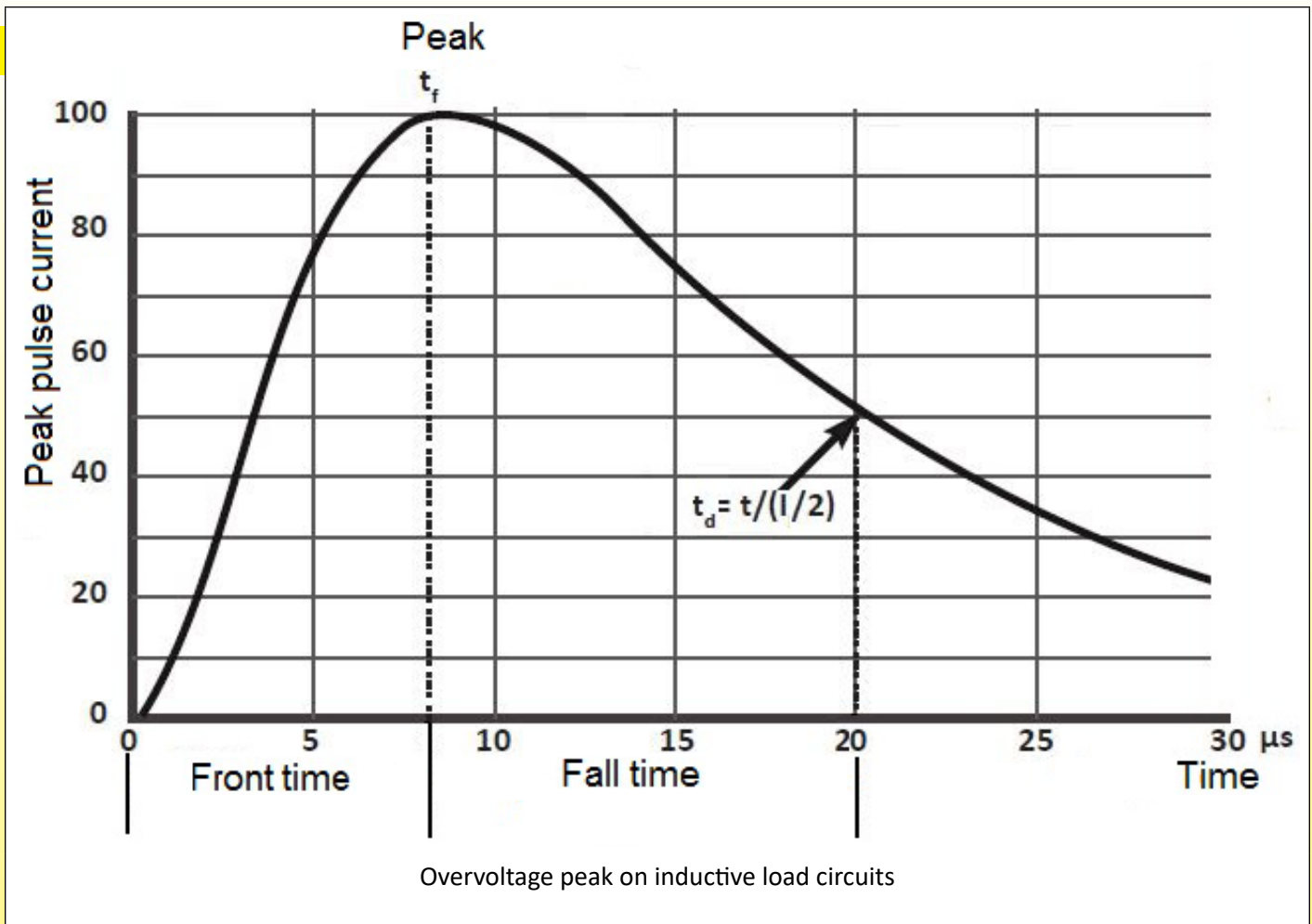

When a switch breaks an inductive load, a fairly high counter electromotive force (counter emf) is generated in the switch's contact circuit. The higher the counter emf, the greater the damage to the contacts.

The quantity of electrical current which flows through the contact directly influences the contact's life. Impulse voltage is the critical value which the switch must withstand when the voltage surges momentarily due to switching an inductive load. They generate a current surge wave, which form has generally a pulse width of 20 to 50µs. Surge pulse rating is specified by its intensity and its width. Pulse width is time measured from pulse start to decrease to 50% of its maximum current value.

Figure shows a 8/ 20µs rated curve.

**Motors loads impulse voltage:**

During start-up, a motor can pull 600% or more of its running current. Thus, a 3 amp motor may actually pull 18 amps or more during start-up. Additionally, when disconnected, a motor acts as a voltage generator as it slows to a stop. Depending on the motor, it can feed back into the circuit voltage well in excess of rated line voltage. These voltages appearing across the separating contacts can cause a destructive arc to exist between the contacts, which can lead to early failure of the contact.

**Lamp loads impulse voltage:**

A tungsten filament lamp, when filament is cold, has an initial inrush current of 10 to 15 time the nominal current.

**Transformers inductive loads:**

When power is removed from a transformer, its core may contain remanent magnetism. If power is reapplied when voltage is of the same polarity as that of the remanent magnetism, the core may go into saturation during the first half-cycle of reapplied power. As a result, inductance will be minimal and an inrush current of perhaps 1, 000% may exist for a few cycles until the core comes out of saturation. Also, as with motor loads, when power is removed from a transformer, the transformer will develop a counter voltage which can cause a destructive arc to exist between separating contacts.

**Distributed line capacitance loads:**

This occurs when a switch is located a considerable distance from the load to be switched. The instant the contacts close, distributed line capacitance charges before load current flows. This capacitance can appear as an initial short circuit to the contacts, and can pull a current well in excess of load current.



Because of permanent improvement of our products, drawings, descriptions, features used on these data sheets are for guidance only and can be modified without prior advice

### Average inductive loads correction factor (if no arc suppression device is used)

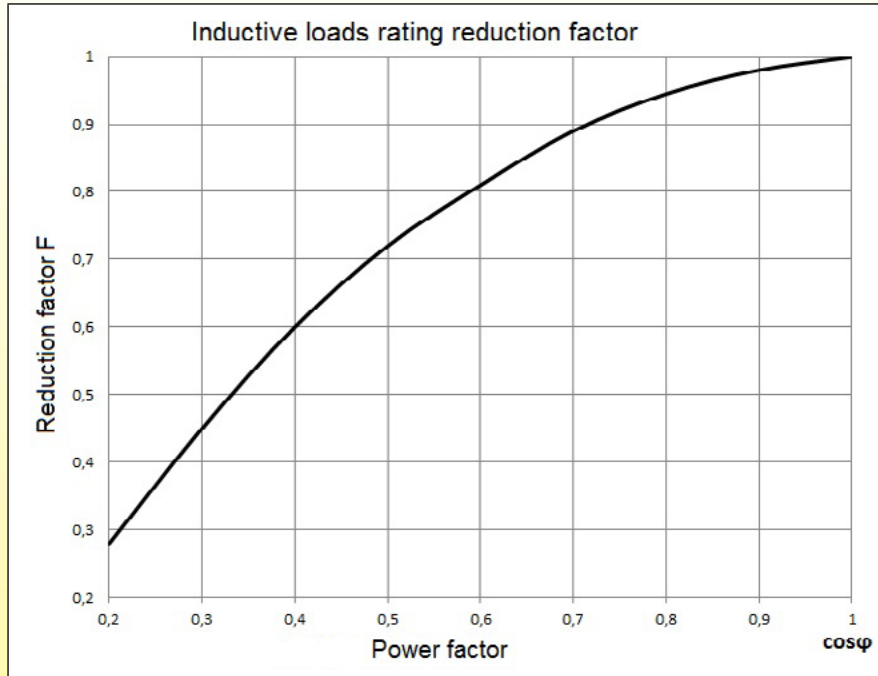

### Self-regulating cables inrush current surge

This is a completely different effect than short transient currents due to the contact switching interaction with the load. This current surge is due to the PTC design of self-regulating cable and takes several minutes to dissipate. Often the heating cable will be at a relatively low temperature (and hence low resistance) when initially energized. The low resistance will thus draw a high start-up current, inversely proportional to the ambient temperature. It can reach 2 times the nominal value given at 25°C by the manufacturer. Refer to records of cable manufacturers to check the inrush current value.

### Self-regulating heating cable inrush current trend

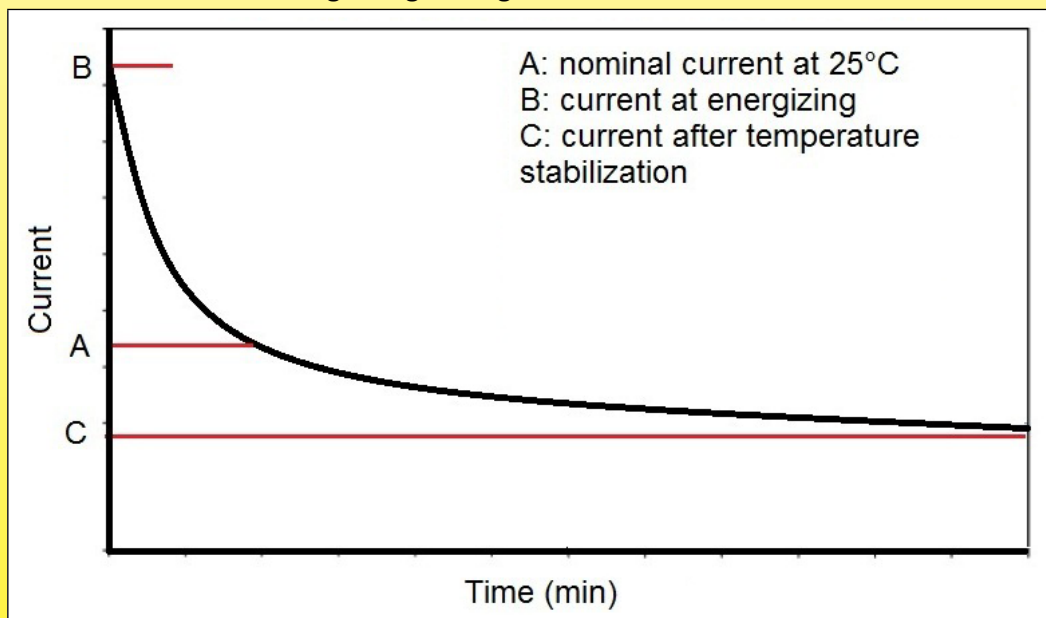

### Indicative average current rating reduction coefficients (AC)

| Resistive load | Filament lamp** | Electromagnetic coil | Transformer | Single phase motor | Three phase motor | Self-regulating heating cables* |
|----------------|-----------------|----------------------|-------------|--------------------|-------------------|---------------------------------|
| 1              | 0.8             | 0.5                  | 0.5         | 0.12/ 0.24         | 0.18/ 0.33        | 0.6                             |

\* Average value, depending on cable ambient temperature at startup, see the manufacturers manuals and Standard CEI60898.

\*\* With hot filament.



## Average electrical life of a thermostat switch rated 15A250V, 300.000 cycles

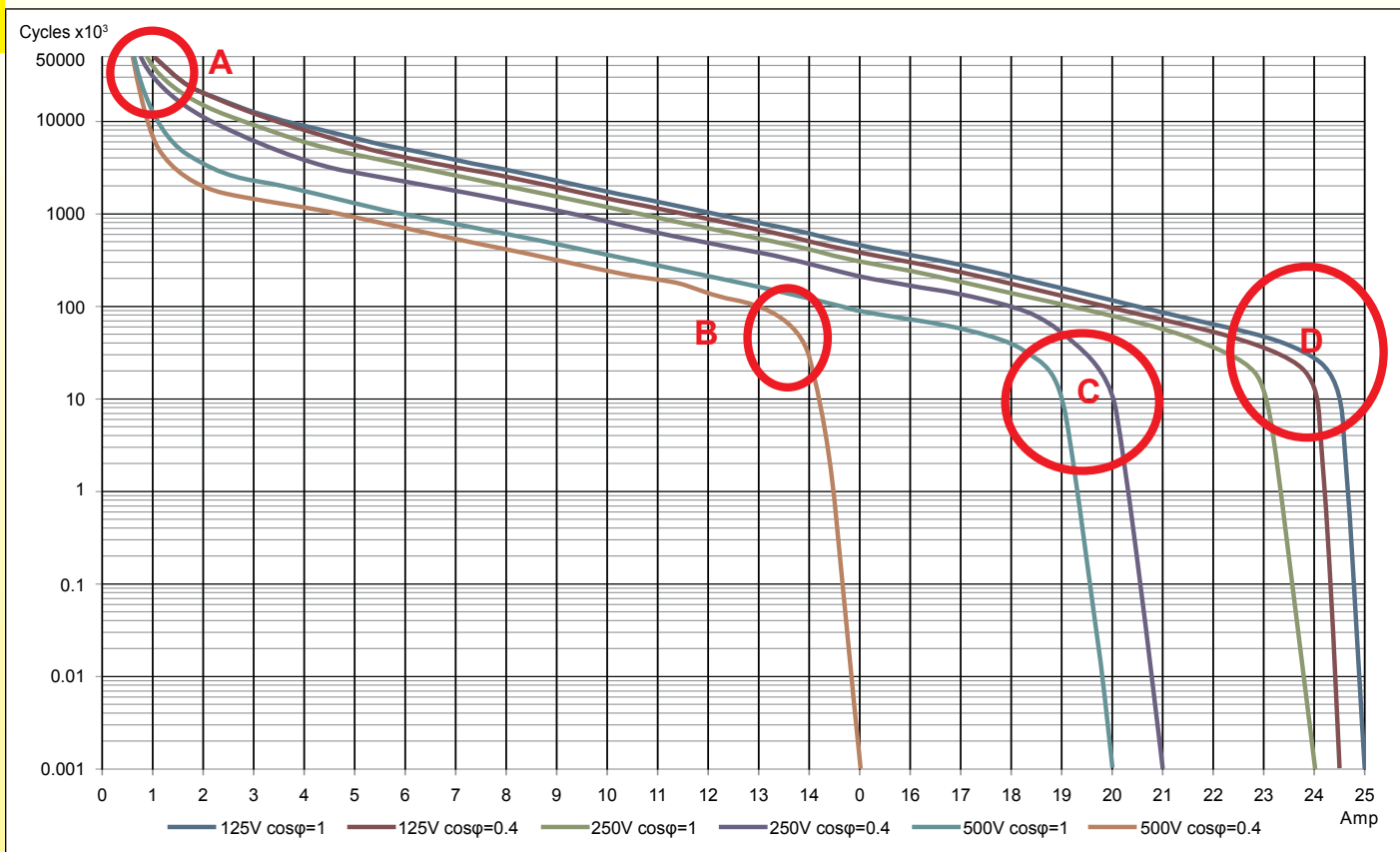

Average approximate values for a snap action mechanism with silver contacts.

Characteristic points:

**A:** zone of mechanical break of the contact blade by metal fatigue.

**B:** contacts fast melting zone due to combination of inductive current, high voltage and high intensity.

**C:** zone of contacts rapid deterioration due to huge arcs.

**D:** zone of contact damage due to heating of the contact blade by the Joule effect and the loss of its elastic characteristics, combined with the electrical arcs.

### 2.3.3 AC AND DC

In the alternative current, the voltage crosses zero in each cycle, causing the arc extinction.

In DC circuits the contact does not pass a zero voltage.

So, the arc will extinguish only when the contacts gap becomes large enough to break the arc (a phenomenon used in arc welding equipment).

In thermostats the contact gap is generally low, from 0.3 to 0.5mm.

In voltages higher than 48VDC, this contact gap is insufficient to extinguish the arc, which continues through the electrical conductivity of the ionized air caused by the passage of current.

Contacts wearing is then extremely fast, and contacts can melt or weld in a few cycles, because the unidirectional flow of current causes a transfer of metal between the contacts.

Any application requiring the use of a thermostat in a DC circuit above 48V should be studied carefully, in collaboration with the supplier of the thermostat, so that reliable technical solutions (increased contact gap, magnetic blow of the arc or other contact protection) can be implemented.

### DC Indicative breaking capacities reduction on snap action silver contacts, with the same lifetime, in resistive circuit

| Current  | 0.2mm contact gap | 0.25mm contact gap | 0.5mm contact gap |
|----------|-------------------|--------------------|-------------------|
| AC, 250V | 15                | 15                 | 15                |
| DC, 8V   | 15                | 15                 | 15                |
| DC, 30V  | 2                 | 2                  | 6                 |
| DC, 120V | 0.4               | 0.4                | 0.5               |
| DC, 230V | 0.2               | 0.2                | 0.25              |





## HIGH FREQUENCY

High frequency applications should be avoided, because they initiate overheating loops in contact blades, which anneals them and modify their flexibility. The contact blade loses its snap action contact and contacts weld or have a premature wear.

### 2.3.4 CYCLING SPEED AND NUMBER OF CYCLES

Electrical contact life is, as we have seen above, the result of many factors.

It is important that the contact has time to evacuate the heat due to the electric arc. Too fast cycling (more than 0.5 per second) cause premature wear, since the contact can not evacuate the rise in temperature.

Most thermostats are designed to withstand:

- 100 000 cycles in control devices.
- 10 000 cycles in safety devices.

In some applications the number of cycles can be much lower. A device designed to withstand 100, 000 cycles at 1A can withstand 25A for a few hundred cycles, and even 100 or 150A for 1 cycle.

Expected life and cycle is a very important parameter to know for the determination of a thermostat.

### 2.3.5 CONTACTS PROTECTION (capacitors, filters, varistors, magnetic blow)

It is possible, by means of accessories external to the contact, to extend or improve its longevity.

These systems are all designed to limit the duration of the arc.

- The oldest is the capacity mounted in parallel to the contact, which allows to use it in DC. This solution was extensively used some decades ago, when there were still domestic DC power supply. It is effective and inexpensive.
- The filter (Inductance and capacitor assembly) is mainly used on slow break contacts to avoid radio interference. It significantly increases the electrical life.
- More recently discovered, Varistors, absorb surges created by contact opening, and limit the arc duration and intensity. They double or triple the life, especially in inductive circuits.
- The magnetic blow, little used, is intended only for DC currents. A strong magnet located around the contact area, deviates the ionized arc, and makes a longer path that extinguishes the arc. This is the solution for high power ratings in 120 and 230V DC loads.
- Inductance: this system is mounted in series with the switch in the immediate vicinity of the contact. When it is well engineered, it has a smoothing effect on the voltage peaks.

### 2.3.6 CONTACTS CONTAMINATION

The presence in the atmosphere of a number of chemicals may have an adverse effect on the contacts operation and life.

In particular:

- A high relative humidity: more intense arcs, because the air loses some of its insulating properties.
- Presence of ammonia: oxidation of contact blades, which are made of copper alloys.
- Presence of silicone oil or vapors: silicone on the contacts stops the electrical current, because when silicone is burned by the electric arc, it becomes silica (aluminum oxide), which is a high temperature resistant insulator.

### 2.3.7 CONTACT SYSTEMS CROSSED BY THE CURRENT

In some small devices (temperature limiting), the contact mounted bimetal strips are themselves the temperature sensing elements.

These strips are not, because of their composition, very good conductors of electricity. The current flow in them causes them to heat by Joule's effect, and this temperature comes to be added to the temperature measurement. This is named "current sensitivity" and "thermal drift" in calibration.

### 2.3.8 CONTACTS OXIDATION

We have seen above that the contact resistance was very low, of the order of a few milli-ohms. Whatever the current passing through it, the resistance is too low to cause significant heating. However, if for one reason or another (contamination, oxidation, insufficient contact pressure, mechanical deformation, etc...), the contact resistance increases, this resistance will heat the contacts if the current is high, and may overheat them enough to melt or burn flammable materials located nearby.

## 2.4 CONTROL ACTIONS

### 2.4.1 TEMPERATURE CONTROL

This the first function of a thermostat. A temperature control action contact is a contact that will cycle periodically, by opening and closing an electrical circuit. This is not a safety device. Contacts must withstand a high number of cycles.

### 2.4.2 THE AUTOMATIC RESET

The automatic reset is a temperature limiter function that does not require, in case of tripping, the intervention of an operator. This type of contact is intended to warn of a malfunction and avoid product destruction if the control device is not working or broken. It resets when the temperature returns to permitted limits.

The current number of cycles of operation of this type of action is between 300 and 10 000.

### 2.4.3 THE MANUAL RESET

A manual reset is a temperature limiting function, which requires, in case of tripping, the intervention of an operator to reset the device. This type of contact is intended to warn of a malfunction and protect the product by shut off the electrical power.



The reset can be done when the temperature is returned to the authorized limits. Manual reset can be accessed or hidden. In general, they cannot be reset without using a tool or without removing a cover or a cap. The current number of cycles of operation of this type of action is between 300 and 10 000.

## 2.4.4 ELECTRICAL RESET

This is the same function as above, but there is no reset button. It automatically resets after disconnection of the power supply.

## 2.4.5 RESET BY TEMPERATURE DROP

Temperature drop reset is an automatic reset after a significant drop in temperature, generally close to the ambient temperature.

This solution is very little used.

## 2.4.6 THE "ONE SHOT"

The "one shot" is a type of contact that can only be opened once. Its use is typically that of ultimate safety device, which definitely cut the power supply. Restarting the application needs a full replacement of it. Its number of operating cycles is 1. This function can be performed by metal alloy melting, plastic pellet melting, glass bead break, triggering of a bimetal disc whose return to the starting position is not possible even in the coldest ambient temperatures.

## 2.4.7 FAIL SAFE

Fail safe is a positive auto control of the device. Any leakage or breakage of the temperature sensing device causes the electrical power shut-off. This function is difficult to define in bimetal thermostats (discs, rod, bimetal), but for thermostat using a bulb and capillary assembly, it defines the mode of operation when it leaks.

The fail-safe mechanisms in bulb and capillary thermostats

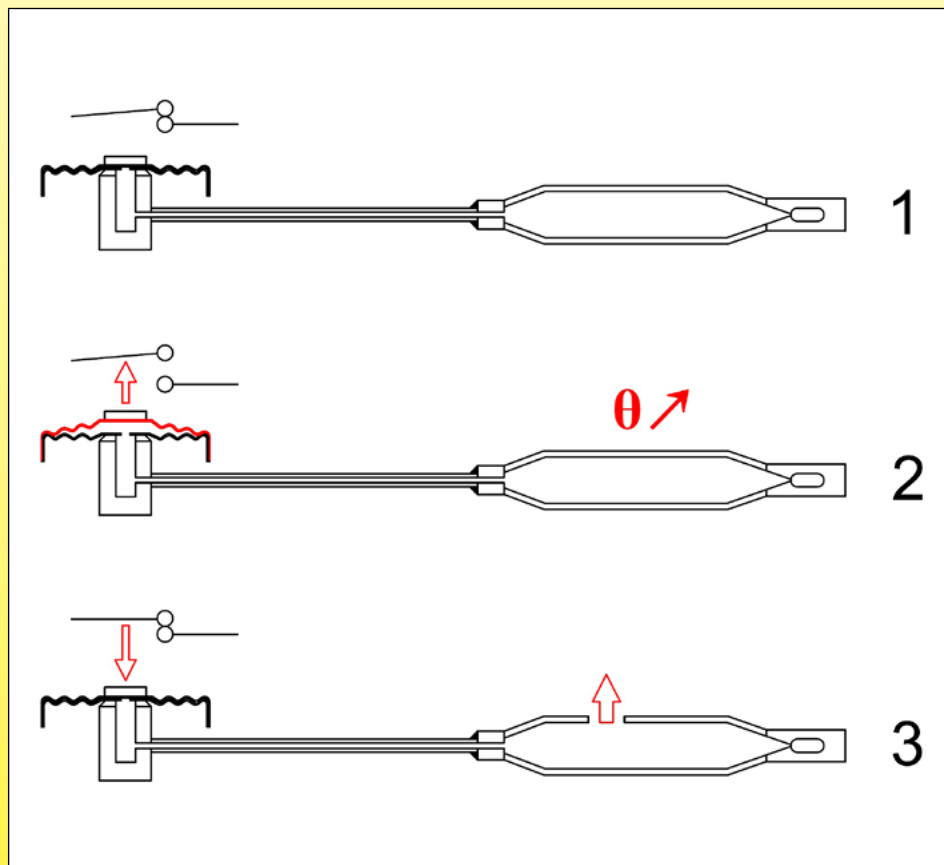

### Diastat Standard Operation:

*In position 1:* a standard diastat is shown in the starting position, at room temperature.

*In position 2:* the temperature of the sensor has reached the set point, and the inflation of the bellows caused the opening of the contact, stopping heating.

*In position 3:* the bulb (or capillary) leaks, the bellows deflates, the electrical contact closes, and the heating is switched on again. But no further expansion is transmitted to the bellows, and nothing can stop nor regulate heating. This is the dangerous situation that failsafe systems must obviate.

Positive safety is primarily used on manual reset thermostat, installed after a standard temperature control unit.

**There are two fail safe systems with a different mode of operation, each system having its own advantages and disadvantages.**



## Liquid expansion type failsafe systems

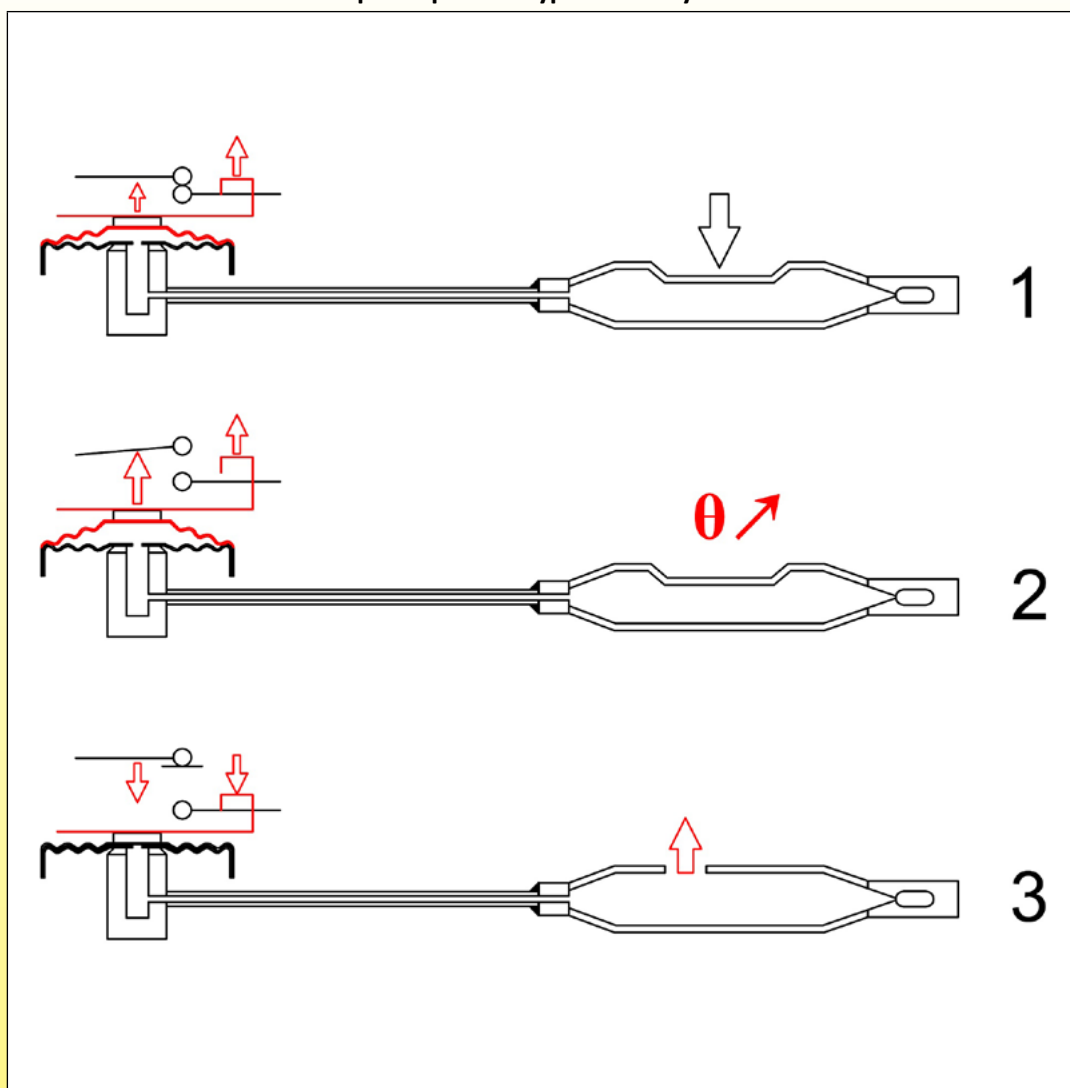

In these systems, after sealing the diastat at ambient temperature, a small bump is made on the bulb, causing an artificial inflation of the bellows (1). It is also possible to produce the same function by sealing the diastat at a negative temperature (-20, -30°C). By these ways the bellows continues to contract at temperatures below room temperature.

When the temperature on the bulb increases (2), the movable part of the electrical contact is actuated by the bellows. When the bulb or the capillary is leaking (3) the bellows is deflated under the thickness it has at ambient temperature, and an auxiliary mechanism (in red) displaces the fixed part of electrical contact out of reach of the movable part, thereby opening the contact. This positive safety system allows easy adjustment of the thermostats trigger temperature, because the mechanism is similar to an adjustable thermostat, and calibration can therefore cover the entire temperature range of these adjustable thermostats.

However, it has two issues:

- The artificial increase of the bellows significantly increases the volume of liquid inside thereof, and thus increases its sensitivity to the ambient temperature on the thermostat head.

### Examples of calibration point drift on a manual reset thermostat with 1.5 m capillary, calibrated at 90°C

| Type of mechanism | Set point drift with head temperature at 0°C | Set point drift with head temperature at 50°C |
|-------------------|--|---|
| With fail safe    | 90+8, 1                                      | 90-9.5  |
| Without fail safe | 90+5, 5                                      | 90-6, 5                                       |

- When the ambient temperature falls under the freezing point, the bellows continues to contract, and can unexpectedly actuate the safety.

This type of false tripping is supervised by the EN60730 standard, which sets the minimum ambient temperature without triggering at -15°C.

However, when using these thermostats in areas with ambient temperature lower than this limit, it is necessary to warm up the thermostat bulb around 20°C to reset the safety when it has triggered.

Because of permanent improvement of our products, drawings, descriptions, features used on these data sheets are for guidance only and can be modified without prior advice



## Boiling style failsafe systems

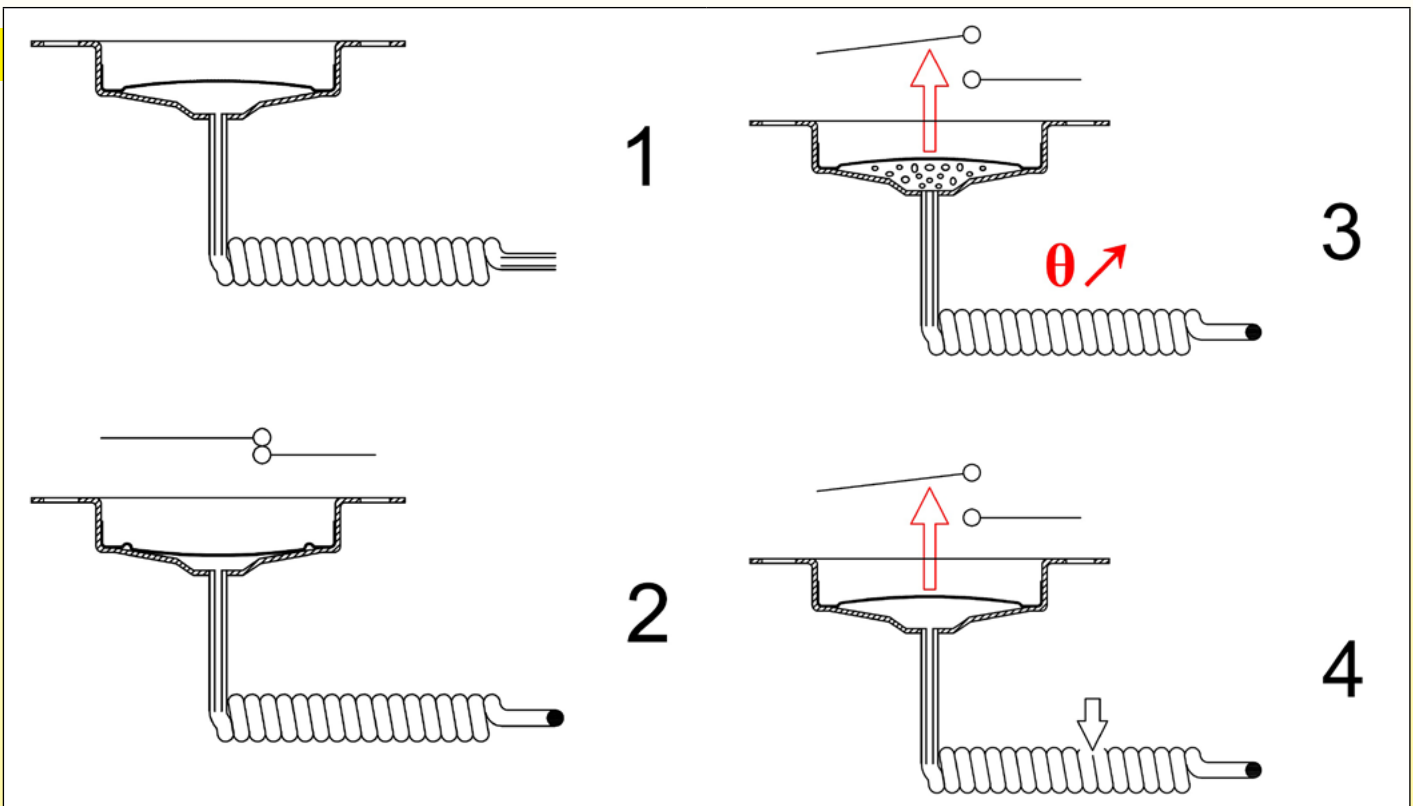

**In boiling type fail safe systems, the bellows of the diastat consists of two dishes, one of which is bumped.**

This bumping is of convex shape, as a bimetallic disc, and snaps from convex to concave when subjected to a force. The diastat, before filling (1) is constructed so that the cup is in the unstressed position is outwardly bulged.

The diastat is then filled with thermostatic liquid under vacuum, then sealed with the cup pushed inwards (2). In this position, the electrical contacts are closed.

In case of temperature rise, the liquid boils at the temperature determined by its composition. The substantial increase in volume caused by the boiling causes the change of shape of the cup, which snaps outwards and opens the contact (3). Upon cooling of the liquid, the force produced by the diastat and required for bumping inwards the cup is insufficient, and it is necessary to press it with a reset button to restore it to its inward form.

In case of punctures or leaks in the diastat, the liquid inside is set to the atmospheric pressure, and the cup snaps outwardly. This system is particularly simple, reliable, and requires no complicated mechanism. It is not sensitive to the ambient temperature on the capillary or on the head, does not trigger unexpectedly when ambient temperatures are too low.

**It has, however, like the previous one, two flaws:**

- Triggering temperature depends of boiling liquid used (Generally mixtures of water, glycol and alcohol), and therefore they are practically limited to values between 60 and 170°C.
- They are sensitive to atmospheric pressure and set point varies slightly with altitude.



Because of permanent improvement of our products, drawings, descriptions, features used on these data sheets are for guidance only and can be modified without prior advice

## 2.5 MULTIPLES CONTACTS

### 2.5.1 CHANGE OVER CONTACTS (SPDT, for: single pole double throw)

The changeover contact is a contact with three terminals. They are a common, a normally closed contact and a normally open contact. During actuation, the contact switches from one position to another. This allows for example to switch off the heating and simultaneously turning on ventilation.

### 2.5.2 SIMULTANEOUS CONTACTS

Simultaneous contacts are independent contacts, with synchronous action.

This is particularly important in cutting a three-phase circuit devices, because the cut of the three phases must be done at the same time.

### 2.5.3 STAGGERED CONTACTS

These contacts are operated by the same measuring system, but at different temperatures.

### 2.5.4 NEUTRAL ZONE CONTACTS

These contacts are parts of the staggered contacts, but with no electrical action between their set points. Their particular application is the air conditioning or refrigeration.

For example the contact # 1 switches off the heating at 100°C, the contact # 2 will turn on the vent at 120°C. Between these two temperatures, no action will be required: this is the neutral zone.

### 2.5.5 ADJUSTABLE DIFFERENTIAL CONTACTS

The differential is the temperature difference existing between the moment the device actuates (opens) a contact and when, as a result of the drop in temperature resulting from its opening action, it resets.

Depending on the type of contact, these differentials can have huge span.

The adjustable differential is a system that allow the user to change it.

For technical reasons and cost, adjustable differential mechanism is reserved for industrial type systems using gas expansion.

### 2.5.6 MIXED CONTACTS

Mixed contacts by means of a combination of different systems above.

The most common combination is a control and a reset contact, or a control and a one shot contact.

### 2.5.7 FLAMEPROOF CONTACTS

A flameproof contact is a contact does not allow the electric arc that it produces to ignite an explosion outside its enclosure.

The electrical arc is not deleted.

There is a difference between the devices whose only the electrical contact is protected and those whose entire mechanism is protected.

### 2.5.8 FLAMEPROOF ENCLOSURE CONTACTS

In these devices only the mechanism of the electrical contact is protected by a flameproof enclosure. The electrical connections are made at the end of a cable secured to the casing of the contact area and must be made outside the hazardous area, or in a suitable connection box.

This solution provides small devices, and low cost.

### 2.5.9 FLAMEPROOF ENCLOSURES

Flameproof enclosures are massive envelopes where the entire device is enclosed. Electrical connections can be made inside the envelope.

## 3. Thermostats types

### 3.1 BIMETAL THERMOSTATS

It is currently the thermostats family where quantities are the most important. Numerous configurations exist, and the current trend is simplification and footprint reduction.

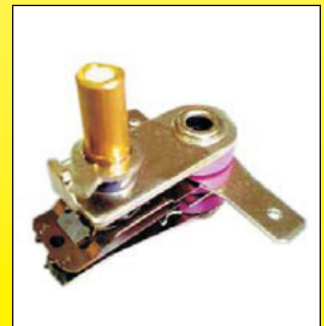
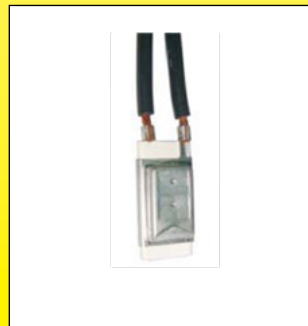



## 3.1.1 FIXED TEMPERATURE BIMETAL THERMOSTATS



Fixed temperature bimetal thermostats are devices whose temperatures are factory fixed, and which have no set point access by the user. They are used, depending on the model, as control devices or safety. The contacts can be slow make or break or snap action, control or reset, normally open, normally close or SPDT. Almost all contact options described above are possible. These devices are divided in two major groups: those sensitive to the current (which are smaller) and those insensitive to the current.

The most common ranges are set from 20 to 180°C.

However, models with ceramic case can be made up to 450°C, and waterproof models to -30°C.

## 3.1.2 ADJUSTABLE BIMETAL THERMOSTATS

They are adjustable by screwdriver or shaft. Their main applications are in small appliances (deep fryers, irons).

They are always control type devices, using a bimetal strip.

Common temperature ranges are from 20 to 300°C.

They are current sensitive or insensitive depending on models.

Models with current sensitive bimetal or heated by a resistance, are used in energy regulators.



## 3.1.3 SPIRAL BIMETAL THERMOSTATS

Bimetallic spirals have been widely used for the production of thermostats. This system is now abandoned by European manufacturers, as it required using a mercury bulb contact, or a slow break contact. There are still only a few manufacturers in the USA, for 110V applications.

These bimetallic spirals (helicoil style) are still used in some air duct thermostats (Called airstats).

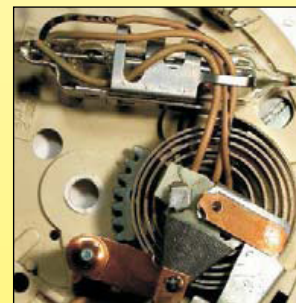

## 3.2 BIMETALLIC EXPANSION THERMOSTATS

### 3.2.1 CARTRIDGE THERMOSTATS

These control devices, adjustables, slow break, have a very high precision, and the lowest possible differential for a mechanical thermostat: less than 1/ 10°C. In general, they are mounted in a 15.8mm dia. bore.

However, because of their slow break, generating radio interferences in 230V, their use in Europe is marginal, restricted to uses in some laboratory hotplates. Common temperature ranges are from 20 to 300°C.



### 3.2.2 CONTACT THERMOSTATS

These control devices, adjustable, slow break, have a very high precision, and low differential: less than 1°C. They are mounted on a flat wall, fixed by 2 screws.

However, because of their slow break, generating radio interferences in 230V, their use in Europe is marginal, restricted to uses in some laboratory hotplates or when low differential are sought. Common temperature ranges are from 20 to 250°C.



Because of permanent improvement of our products, drawings, descriptions, features used on these data sheets are for guidance only and can be modified without prior advice



Because of permanent improvement of our products, drawings, descriptions, features used on these data sheets are for guidance only and can be modified without prior advice

## 3.2.3 BIMETAL ROD THERMOSTATS



It is currently the main application of bimetallic systems. The bimetallic rod actuates a contact system. The setting can be fixed or with a graduated knob. The contacts are control, manual reset or mixed types.

The main applications are:

- Household storage water heaters. They are controlled by a screwdriver adjustment, with single-pole switching thermostat for temperature control, with temperature sensing made by the rod, and double pole switching for the manual reset, with temperature sensing usually made by a bimetal disc located at the bottom of the tank. They are protected by the cover mounted under the water heater.
- In water heaters and industrial tanks. The temperature control devices are then split: one for control and one for safety. They are mounted in IP65 waterproof housings.
- In hydraulic systems, where they are used for oil temperature control. They have 1, 2 or 3 staggered contacts to provide different levels of alert and security.

Current temperature ranges span from -50 to 400°C. However, some special models can reach 800°C.

## 3.3 LIQUID EXPANSION THERMOSTATS

### 3.3.1 MERCURY EXPANSION IN GLASS TUBE

This is one of the first thermostat systems, invented after the mercury thermometers. A wire is inserted in the capillary glass tube. When the mercury touches the wire, the contact is established. This type of thermometer has long been the reference instrument for precise temperature control. It has no more serial applications.



### 3.3.2 BULB AND CAPILLARY THERMOSTAT



This is the most common remote measurement and temperature control. The capillary lengths can be up to 3 meters but with a significant drift due to the amount of liquid within the capillary.

In this series, fail safe devices may be produced. Current ranges of temperature span from -50°C to 400°C, exceptionally up to 760°C.



### 3.3.3 LIQUID FILLED ROD THERMOSTATS

This family is a variant of the bimetal expansion rod thermostat. It differs by a greater resistance to vibration but a longer response time. Applications are identical. Current ranges of temperature ranging from -50°C to 400°C, exceptionally up to 760°C.



### 3.3.4 PIPE THERMOSTATS

These thermostats use a bulb and capillary mechanism, thermostat but with a very short capillary and a bulb beneath the housing on a pipe radius formed plate. The housing has a system for fixing the plate on a pipe.

Usual setting of these control these devices are between 0 and 120°C.



### 3.3.5 ROOM THERMOSTATS

These thermostats use a bulb and capillary mechanism but with a very short capillary and a bulb located at the side or at the back of the housing. This system is particularly useful for professional and industrial equipment. Current ranges of temperature span from -40°C to 120°C.

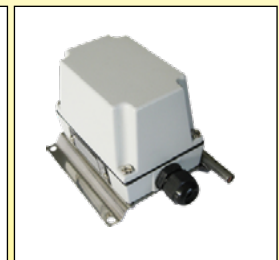
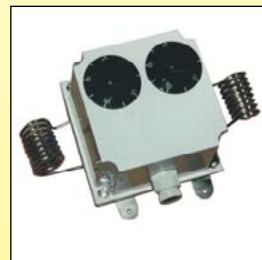

## 3.4. GAS EXPANSION AND VAPOR PRESSURE THERMOSTATS

### 3.4.1 BULB AND CAPILLARY ROOM THERMOSTAT

These vapor pressure devices are mainly used in electric convector thermostats, due to their low differential and low thermal inertia.

Current temperature range: 4 to 40°C.



### 3.4.2 "WAFER" ROOM THERMOSTATS

It is currently derived from incubator thermostats used in poultry incubators since more than 50 years. The sensitive part is a barometric type capsule (Named 'capsule de Vidie'), filled with low boiling temperature liquid. They are widely used in household room thermostats. Current Page: 4 to 40°C.



### 3.4.3 CAPILLARY THERMOSTATS

These thermostats are used for controlling the temperature of the refrigerating systems. The low thermal inertia of the capillary system, and the possibility of obtaining significant differential is the main feature of these vapor pressure devices.

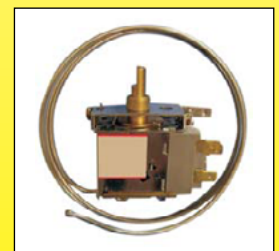

Because of permanent improvement of our products, drawings, descriptions, features used on these data sheets are for guidance only and can be modified without prior advice





Because of permanent improvement of our products, drawings, descriptions, features used on these data sheets are for guidance only and can be modified without prior advice

### 3.4.4. BULB AND CAPILLARY THERMOSTATS

They are mainly used in industrial applications because the vapor pressure can achieve quite easily adjustable differential devices.

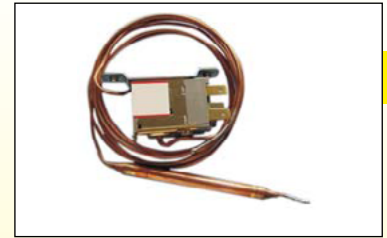

### 3.4.5 AIR DISPLACEMENT THERMOSTATS

These devices were using a filament style heating system in a glass bulb partially filled with air and containing mercury. Pushed by the expanding air, the mercury passed through a tube into a compartment containing an electrode with which it established an electrical contact.

This system, coupled with a slow break bimetal thermostat contact avoided contact triggering, and achieved very low differential and high electrical rating. This system, very accurate, very reliable, has completely disappeared.



### 3.4.6 THERMOMETERS

The gas expansion thermometers are used in industrial applications, they have a low thermal inertia and can be used in high temperatures.

## 3.5 PHYSICAL STATE CHANGE THERMOSTATS

### 3.5.1 "CALORSTATS"

They use the wax melting temperature expansion. There is little use of them in systems operating an electrical contact, but they are widely used to provide mechanical movements (Car engine thermostats, radiator thermostats, door locks, valve control).

This system can actuate an electrical contact, or operate a valve to control the flow of water when the temperature changes.

Current ranges from 30 to 150°C.



### 3.5.2 THERMAL FUSES

This is the main system used in thermal cut out. Millions of these devices are currently produced in the world. It is a highly reliable system, whose operation is safe. The electrical contacts are either cut by the conductor melting (Rating generally limited to 4A) or by melting of a pellet releasing a spring contact (Rating up to 25A).

Current ranges from 60 to 300°C.

The melting part is made of metal or plastic.

This system, known as TCO (thermal cut-off) is the ultimate security system. It is inexpensive.

A variant of these systems are also used in non-electric appliances for releasing a mechanism, in particular in fire detection apparatus.



### 3.5.3 BOILING THERMOSTATS

The most common thermostat of this type is the failsafe capillary limiter with manual reset.

This system measures the boiling of a liquid contained in a capillary or a bulb at the end of the capillary. Temperature sensing on +/- 300mm capillary is required to operate the contact. For this reason, models often have their capillary curled at the end, with dimensions similar to a bulb. These devices are always fixed temperature types, most of time calibrated within the 50 to 170°C span, and the capillary length is limited to +/- 900mm for transmission of the excess pressure due to the boiling reasons or depression due to the rupture of the capillary.

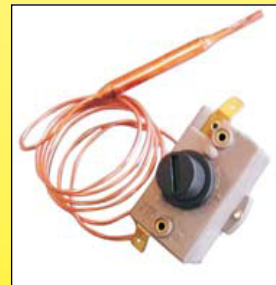



## 4. Applications

### 4.1 THERMOSTATS APPLICATION

| Principle             | Family   | Sub family  | Application  |
|-----------------------|--|---|--|
| Co-laminated bimetals | Fixed setting                                    | Current sensitives                                    | Coils protectors, small appliances, automotive, rechargeable batteries |
|                       | Fixed setting                                    | Non sensitives to current                             | Small appliances, HVAC, refrigeration equipment                        |
|                       | Adjustable setting                               |   | Irons, grills, crepes makers   |
|                       | Spiral   |   | Thermometers, aistats  |
| Double metals         | Cartridges<br>Surface sensing                    |   | Heating plates, flat heaters, medical equipment                        |
|                       | Rod  | For incorporation                                     | Household water heaters  |
|                       |  | Professionnals  | HVAC   |
|                       |  | Industrials   | Tanks, Hydraulic power units, heaters                                  |
|                       | Explosion proof                                  | Chemical industry                                     |  |
| Liquid expansion      | Glass  | Laboratory  | Various  |
|                       | Bulb and capillary for incorporation             | Appliances OEM  | Ovens, cookers, washing machines, dishwashers, boilers                 |
|                       | Bulb and capillary with protection housing       | Semi-professionnel                                    | OEMs electro, kilns, ovens, air heaters                                |
|                       | Bulb and capillary with metal protection housing | Industrial and/ or hazardous area, heavy construction | Factories, maintenance, heat tracing                                   |
| Vapor pressure        | Bulb and capillary                               |   | Electric heaters, refrigerators thermostats                            |
|                       | Membrane   |   | Household room thermostats   |
|                       | Air displacement                                 |   | No more used   |
| Physical state change | Wax  |   | Automotive, hot water central heating                                  |
|                       | Compounds melting                                | Conductor melting                                     | Small appliance, coils, batteries, electronic                          |
|                       |  | Pellet melting  | Household appliances, electric heating, motors                         |
|                       | Boiling  | Capillary   | Heaters, electric air heaters, heat pumps                              |
| Glass bulb            |  | Air conditionning, fire detection                     |  |



## 5. Terminology and vocabulary

### 5.1 VOCABULARY

Standards EN60730 and EN 60335 define, sometimes with differences, the vocabulary to use. However, it is often different from that used in practice.

#### Usual vocabulary:

*Set point*: the value set on the temperature control device, corresponding to the temperature to reach.

*Differential*: the temperature difference between the opening and closing of the contact.

*Snap action*: contacts open and close instantly.

*Manual reset*: action to turn on by manual intervention, to heating position contacts opened by a temperature rise that did not automatically return to closed position when the temperature drops.

*Automatic reset*: contact that is automatically closed when the temperature drops.

*Sensing control*: automatic control in which initiation is by an element sensitive to the activating temperature.

#### Definitions of the different thermostatic systems according to EN60335-1

§3.7.1 Thermostat: temperature sensing system of which the operating temperature may be fixed or adjustable and which, during normal operation, maintains the temperature of the controlled part within certain limits by automatic opening and closing of a circuit.

§3.7.2 Temperature limiter: temperature-sensing device, the operating temperature of which may be either fixed or adjustable and which during normal operation operates by opening or closing a circuit when the temperature of the controlled part reaches a predetermined value.

NOTE A temperature limiter does not make the reverse operation during the normal duty cycle of the appliance. It may or may not require manual resetting.

**Temperature limiter**: temperature sensing control which is intended to keep a temperature below or above one particular value during normal operating conditions and which may have provision for setting by the user.

A temperature limiter may be of the automatic or of the manual reset type. It does not make the reverse operation during the normal duty cycle of the appliance.

§3.7.3 Thermal cut-out: device which during abnormal operation limits the temperature of the controlled part by automatically opening the circuit, ... and is constructed so that its setting cannot be altered by the user.

**Thermal cut-out**: temperature sensing control intended to keep a temperature below or above one particular value during abnormal operating conditions and which has no provision for setting by the user.

A thermal cut-out may be of the automatic, manual reset or non-resettable type.

§3.7.4 Self-resetting thermal cut-out: thermal cut-out that automatically restores the current after the relevant part of the appliance has cooled down sufficiently.

§3.7.5 Non-self-resetting thermal cut-out: thermal cut-out that requires a manual operation for resetting, or replacement of a part, in order to restore the current.

NOTE Manual operation includes disconnection of the appliance from the supply mains.

§3.7.6 Protective device: device, the operation of which prevents a hazardous situation under abnormal operation conditions.

§3.7.7 Thermal link: thermal cut-out which operates only once and requires partial or complete replacement.

**Fail safe temperature limiter**: the fail safe in a thermostat is defined by the EN60730-2-9 Standard § 6.4.3.101, as a temperature control device wherein a leakage of the filling fluid does not increase the temperature set point. More generally a system is said to be failsafe, when a loss of fluid (including electricity) leads the equipment to a stable safety state. The safety state must be maintained over time.

#### Thermostats recommended applications:

IEC (EN) 60730-1 Standards "Automatic electrical controls for household and similar use" and especially IEC (EN) 60730-2-9-(2008): "Particular requirements for temperature sensing controls" are the standards that define the functional characteristics of thermostats. Appendix EE of the latest version of the standard describes all recommended applications for these devices.

### 5.2 COMMON VOCABULARY USED TO DESIGNATE A THERMOSTAT

Dozens of names are used by the customer to designate thermostats. We can mention:

aquastat, airstat, bimetal sensor, temperature sensor, temperature switch, temperature detector, thermal sensor, thermal switch, temperature limiter, thermal pellet, pellet thermostat, thermal protector, temperature controller, sensor, temperature probe, temperature sensor, thermostat.

Some brands have passed into the vocabulary:

Klixon: Texas trademark instrument means a bimetal disc thermostat.

Combistat: Stork trademark refers to a contact thermometer.

Vigitherme: Heito trademark refers to a thermostat bimetal disc.

Ipsotherm: Comepa trademark refers to a thermostat bimetal disc.

Calorstat: Brand used by Vernet thermostat, refers to an automotive water circuit valve.



## 6. Important extracts of standards related to control or safety circuits

### **Electrical cut out:** (IEC 60335-1)

**§3.8.1 All-pole cut out:** cutting in two conductors in a single operation, or for three phase units, the cut of the three conductors in a single step... Note: for three-phase, the neutral lead is not considered as a power conductor.

**§22.2: Phase cut out:** single pole protection systems cutting heating elements in single pole circuits of Class 01 devices and continuously connected Class 01 devices, must be connected to the phase conductor.

### **Electrical conductors colors:** (IEC 60446)

**§3.1 ...** For the identification of leads the following colors are allowed: black, brown, red, orange, yellow, green, blue, purple, gray, white, pink, turquoise.

**§3.2.2** Neutral conductor or center conductor: when a circuit includes a neutral conductor or neutral conductor identified by color, the color used for this purpose should be blue...

Note 2 – In the United States of America, Canada and Japan, identifying with white or natural gray colors for the neutral conductor or center conductor is used as a replacement for the identification by the light blue color.

**§3.2.3** AC phase conductors: black and brown colors are the favorite colors for the phase conductors of AC systems.

**§3.3.2** Conductor protection: the two-tone green-and-yellow combination must be used for identification of the protective conductor to the exclusion of any other use. The green-and-yellow is the only recognized color scheme for the identification of the protective conductor.

Note 2 – In the United States of America, Canada and Japan, identifying with green color for the protection conductor is used as a replacement for the identification by the two-tone green-and-yellow combination.

### **Fail safe, functional safety, safety levels:**

It is required by the European Directive 97/ 23 dealing with heat generators, pressure equipment and boilers as follow: “the procedures for conformity assessment and the essential safety requirements of the Directive apply to the complete safety chain. The requirements for the sensor itself can be different according to the safety design principles, for instance: redundancy or fail-safe”. Many “product” standards of the IEC (EN) 60335-xxx series require this type of safety.

**Definitions related to the functional safety:** this concept was introduced by the CEI 61508: 1998 Standard. “Functional Safety for electrical/ electronic and programmable electronic (E/ E/ PES) systems”. This standard defines the requirements and provisions for the design of electronic and programmable complex systems and subsystems. This is a general standard that can be used in all industrial sectors. The categories of protection of industrial heating equipment have been classified into three levels by the old EN 954-1 Standard.

**Level 1** includes mainly the process control instrumentation: temperature sensors, thermostats, controllers, programmers. This level provides a control either permanently or in a sequence by programmed commands initiated by the operator (for example: control disc, bimetal, bulb and capillary thermostats, electronic temperature controls).

**Level 2** consists essentially of an instrumentation composition close to that of level one, but functionally completely independent of this level.

This level 2 protects the process by a discontinuous unsystematic function, that is to say not initialized by the operator, from threshold violation information on critical parameters of the process.

(For example, disc thermostat + disk limiter, bulb and capillary temperature limiters + bulb and capillary thermostat, double electronic controllers).

**Level 3** is the ultimate protection of the process. It does not include identical instrumentation to those of Level 1 and 2, but devices working without auxiliary energy (for example: fixed temperature limiters with manual or automatic reset on circuits controlled by electronic controllers, thermal fuses for systems controlled by disc or bulb and capillary thermostats, or by electronic controllers).



## 7. Installation

The proper functioning of a thermostat depends primarily on the correct choice of the component, but also the conditions of its installation. Conditions used to calibrate regulating and control equipment in the factory are always ideal laboratory conditions, ensuring measurement accuracy and repeatability. These conditions are rarely those found in practice when installing thermostats. However, with a minimum of constraints, it is possible to optimize assemblies.

One's will always bear in mind these two essential rules:

- A thermostat measures the temperature where the sensing element is located, and it is therefore necessary that this place is representative of the temperature that must be controlled.
- The thermal inertia is the most common causes of poor regulation. A thermostat does not have an instant response to a temperature change.

### 7.1 GENERAL RULES

#### • THERMAL CONDUCTIVITY

The temperature of a medium (liquid, air, metal) decreases progressively as the distance from the heat source. This decrease, called thermal gradient is inversely proportional to the thermal conductivity of the medium. For good temperature control, first step is to make this decrease as low as possible: by stirring the liquid, stirring the air, using metals that are good conductors of heat.

In unstirred liquid baths, thermal variations that rise several tens of degrees between different measurement points are quite common. It is the same in the air.

#### • RESPONSE TIME

Practically speaking, the time taken by a device to change temperature is proportional to its mass and inversely proportional to its thermal conductivity.

Subject to the same variation of temperature, a large block of copper takes longer to heat up than a little. A block of pure silver of the same weight will react much more quickly.

In one room, sun exposure will raise rapidly the temperature of the ambient air because its mass is low, but the walls will react much more slowly because they are much more massive, even if their thermal conductivity is higher. Therefore, to control the air conditioner, make sure that the thermostat measure the temperature of the air and not of the walls.

Thermal conductivity of some materials

| Materials                  | Thermal conductivity at 20°C (W•m-1•K-1) | Materials                 | Thermal conductivity at 20°C (W•m-1•K-1) |
|----------------------------|--|---------------------------|--|
| PU foam                    | 0,025                                    | Titanium                  | 20                                       |
| Air (atmospheric pressure) | 0,026                                    | 304 Stainlss steel        | 26                                       |
| EPS                        | 0,036                                    | Mild steel                | 46                                       |
| Fiber glass wool           | 0,043                                    | Platinum                  | 72                                       |
| Cork                       | 0,043                                    | Iron                      | 80                                       |
| Wood (Average)             | 0,16                                     | Cast iron                 | 100                                      |
| Abestos                    | 0,17                                     | Silicium                  | 149                                      |
| Epoxy                      | 0,25                                     | Aluminum alloy (with SiC) | 150-200                                  |
| Nylon                      | 0,25                                     | Pure aluminum (99.9%)     | 237                                      |
| PPS (Ryton)                | 0,3                                      | Massive silicium carbide  | 250                                      |
| Vulcanized rubber (EPDM)   | 0,4                                      | Gold                      | 317                                      |
| Water                      | 0,63                                     | Copper                    | 390                                      |
| Concrete                   | 0,92                                     | Silver                    | 429                                      |
| Glass                      | 1,23                                     | Graphite                  | 500-2000                                 |
| Bakelite                   | 1,42                                     | Diamond                   | 1000-2600                                |
| Quartz                     | 10                                       | Graphene                  | 4000-5300                                |

It is easily possible to see that if a thermal gradient takes 1 second to be transmitted in a silver part, it will take 1.1 seconds in copper, 2.5 seconds in aluminum alloy, 4.3 seconds in iron, 6.3 seconds in mild steel, 16.5 seconds in stainless steel, 680 seconds (more than 11 minutes) in non-stirred water and 16500 seconds (more than 4 hours) in still air.

#### • TIME NEEDED TO HEAT

An issue frequently raised, and that many consider as associated with thermostats is the time it takes to heat a product. In fact, at constant power, the amount of heat (energy) required to heat a product depends on its mass and its heat capacity, and not on the thermostat.

Specific Heat capacity (or specific thermal capacity) is the energy it takes to bring a body to raise its temperature by one degree kelvin for a mass of one kilogram. It is expressed in joules per kelvin per kilogram (J/ K). It originates from the "calorie" that was defined as the amount of heat required to raise 15°C to 16°C the temperature of one gram of water.



The table below gives some common values:

| Materials           | Specific heat capacity (J*kg <sup>-1</sup> *K <sup>-1</sup> ) | Materials    | Specific heat capacity (J*kg <sup>-1</sup> *K <sup>-1</sup> ) |
|---------------------|---|--------------|---|
| Gold                | 129   | Granite      | 800   |
| Silver              | 240   | Concrete     | 880   |
| Brass               | 377   | Aluminum     | 897   |
| Copper              | 385   | Dry Air      | 1005  |
| Iron                | 444   | Wood         | 1760  |
| Diamond             | 502   | Olive oil    | 2000  |
| 304 Stainless steel | 510   | Alcohol      | 2450  |
| Graphite            | 720   | Liquid water | 4180  |

One can easily notice that the same power, whether 600 seconds are needed to heat one kilogram of water, it will take only 290s for oil, 145s for air, 73s for stainless steel, 55s for copper, and 18s for gold. The heat capacity is an extremely important parameter in the definition of a thermal system.

## • OVERHEAT AND HEAT ACCUMULATION

Many heating systems accumulate heat before transmitting it to the environment.

This is especially the case with sheathed heating elements, where heating wires are coated with magnesia, and then covered with stainless steel tube. Before the stainless steel sheath begins to warm, the entire interior of the heating elements has heated up.

When the power is then turned off, the heat accumulated inside will continue to dissipate, and the temperature of the outer shell will continue to rise. A temperature control which regulate by measuring the temperature of the outer shell will be false.

## 7.2 WALL AND PIPE MOUNTING THERMOSTATS

These thermostats are intended to be mounted on walls. This covers bimetal disc thermostats, with or without bracket, and pipe formed models.

The following requirements must be respected:

- In the case of thermostats with a flat sensitive part, the mounting wall must be flat. In particular, if it is needed to measure the temperature of a small diameter tube, it is mandatory to weld or solder a heat conductive part made of copper or brass on the tube surface, with a flat surface on the side facing the thermostat.
- In the case of thermostats whose sensitive part is curved to match the shape of the wall (tanks, pipes): use thermal contact grease between the thermostat sensing face and the wall, insulate the thermostat body to limit the influence of the ambient temperature, have in mind that the whole thermostat must withstand the maximum or minimum temperature of the wall. Check if these temperatures are compatible.

## 7.3 AIR DUCTS THERMOSTATS

Thermostats must be installed in an area where there is good air circulation. Avoid corners, angles. The thermostat should be located close to the heating element (or cooling) to be quickly influenced by temperature changes. The extended bracket disc thermostats must be mounted on a wall that is not influenced by a temperature other than that of the air stream.

Attention to the use of bimetallic rod thermostats in air ducts: these devices generally have very fast response time to temperature changes, and some models are not suitable for use as safety device because they trigger too fast.

## 7.4 ROD THERMOSTATS

Rod thermostats should be mounted on fittings provided for this purpose. The rod cannot be bended, welded, soldered, and no external device must hinder the rod expansion.

The whole sensitive part of the rod must be immersed in the air or liquid that it must control.

Do not mount the thermostat on a stack of fittings and rod must be in an area representative of the temperature of the tank. Avoid areas without natural convection or no stirring.

Whatever the installation, the thermostat head must not exceed the maximum allowable temperature. In particular, when mounting thermostats on high temperature equipment, the head must be kept away from hot walls.

Use pockets adapted to the rod diameter, and do not hinder expansion movements. If you want to get accurate settings and low differential, put thermal grease between the pocket and the rod.

## 7.5 BULB AND CAPILLARY THERMOSTATS

The bulb and capillary thermostats are provided to measure the temperature with the bulb located inside the medium to control. However, the capillary and the rest of the diastat are influenced moderately by temperature. It is therefore important not to expose them to temperatures too high, and in particular never exceed the maximum allowable temperature of the thermostat head. Capillaries and in particular capillary junctions with bulb are fragile and care must be taken not to bend capillaries with a radius smaller than 5mm, or near the bulb. Breakage or leak



Because of permanent improvement of our products, drawings, descriptions, features used on these data sheets are for guidance only and can be modified without prior advice

of the capillary after sharp bending voids any warranty on the equipment. Overheating bulbs or capillaries on liquid expansion models cause unwanted boiling of the liquid and the destruction of the thermostat. Cutting or drilling capillary or bulb destroys the mechanism, and the thermostat does not stop heating when the temperature rises. If this risk is important in your application, be sure to use failsafe thermostats.

## 7.6 WINDINGS THERMOSTATS

Windings protectors must be installed to measure the fastest way the temperature rise of the winding. They must not be bended or distorted during installation inside the coil. Before to be incorporated into windings that must later be impregnated by resin or varnish, ensure that these thermostats support these operations. Our office is at your disposal to give you technical advice.

Calibration temperatures warning: thermal protectors are calibrated at zero current and their operating temperature is sensitive to current. In your application, depending on the current rating of your device, their set point can be shifted down. Use thermostats drift curves to define thermal drift temperatures. Many thermal protectors have metal enclosures electrically alive. Be sure to install them safely, with proper electrical insulation and not in contact with grounded or accessible parts. For these devices, class 1 and class 2 electrical insulation sleeves can be provided on request.

## 7.7 THERMAL CUT OUT

Thermal fuses are the components the most susceptible to wrong installations.

Their terminals are heat conductors: welding or soldering them can cause the fuse to open by thermal conductivity. Do not make soldering at less than 15mm of the housing. The soldering duration shall not exceed 3 seconds. Terminals wires are also sensitive to strength and torsion. Be careful not to apply significant forces (1.3 N max).

Bending terminal wires should be preferably made with a wire bending machine. Do not bend or crimp at less than 5mm from the body. Do not crush the body.

Sensitivity to temperature: thermal fuses must not remain continuously exposed to temperatures that are too close to their cutoff temperature. Respect the maximum allowed permanent temperature given in technical data sheets. They are also sensitive to current and can trigger by Joule effect if the rating is too high.

## 7.8 VAPOR PRESSURE BULB AND CAPILLARY THERMOSTATS

These thermostats are particularly sensitive to the position of the capillary or of the bulb relative to the thermostat head. Observe the position indicated on the data sheets for each device.

## 7.9 EXPLOSION PROOF THERMOSTATS

The explosion-proof devices require special care during assembly. A specific mounting and assembly instruction manual is supplied with each unit.

- Explosion-proof enclosures: these housings are designed to withstand an explosion occurring within the housing. It is therefore important to take particular care that the screws of the cover (these screws cannot be replaced by others models with different mechanical resistance), to ensure the cleanliness of the sealing surfaces, not drill holes in the boxes, not to replace original cable glands by others, properly tighten the cable glands, ensuring that their gasket is adapted to the diameter of the cable used.

- Explosion proof Switches: In thermostats using this system, only the electrical part of the switch mechanism is enclosed in a flameproof enclosure. By this way, the outer casing of the thermostat does not provide explosion protection, but only requires at least IP65 ingress protection. Electrical connections must be made on the cable coming out of the unit, outside the hazardous area or in a suitable junction box.



Because of permanent improvement of our products, drawings, descriptions, features used on these data sheets are for guidance only and can be modified without prior advice





# Comparison of different models of thermostats



Because of permanent improvement of our products, drawings, descriptions, features used on these data sheets are for guidance only and can be modified without prior advice



## Disc thermostats

Used as control thermostats or as a safety thermostat with manual reset, these thermostats have a disc made of two different metals laminated together for temperature sensing element. These two metals have different expansion coefficients. Therefore a dome bumped disc will gradually change shapes with increasing temperature until it suddenly snaps from concave to convex. It also comes back with a snap action to its original form when temperature drops. This sudden change activates a contact blade. These thermostats exist with one, two or three pole contacts. Technology to obtain accurate temperatures and low differentials is complex and few manufacturers offer accurate values and low differentials. JPCI is one of the very few manufacturers offering three poles models.



## Surface mounting Bimetal strip thermostats

These control devices, adjustable, slow break, have a very high precision, and low differential: less than 1°C. They are mounted on a flat wall, fixed by 2 screws. However, due to their slow break, generating 230 parasites, their use in Europe is marginal, limited to laboratory uses or when low differential are sought. Common temperature ranges are from 20 to 250°C.



## Energy regulators

The energy regulators are a type of thermostat bimetal having a heating resistor in contact with this miniature blade. The power of this internal resistance heats the blade, which is deformed and cuts off the supply of the resistance. The blade is then cooled and the contact closes and a new cycle begins, like a flash. The setting pin to change the ratio between the time of opening and closing, and provides the electrical connection to an external load in parallel with the internal resistance. This simple system allows you to adjust continuously the resulting power a heater. The power supply circuit must be specified as the miniature internal heater is made in terms of this tension.



## Bulb and capillary control thermostats

Bulb and capillary thermostats sensing device, usually named "Diastat" is a closed chamber made of a bulb, a capillary and a bellow made of two membranes, filled under vacuum with liquid. When temperature around the bulb increases, the liquid volume expands and inflates the membrane. This displacement is used to actuate a snap-action switch mechanism. A threaded shaft, used to modify the bellow position allows temperature adjustments. In standard devices (not fail safe), when a leak occurs in the Diastat, the bellow deflates and electrical contacts remains closed when the temperature rises. The most common ranges go from -35 to +320°C. Higher set points up to 750°C are possible but they require capillary liquids that withstand these temperatures without boiling. JPCI is one the very few companies manufacturing these models. These high temperature versions (ranges above 400°C) use a liquid metal as filling liquid, usually a Sodium Potassium eutectic. In case of breakage or leak of the Diastat, this liquid is flammable on contact with water or atmospheric moisture. It is therefore necessary to take this point into account in their applications.

The capillary thermostats are subject to drift due to temperature variations on the capillary and the bellows. The bulb and capillary thermostat differential is usually not adjustable, and is about 2.5% of the temperature range. They are available in single pole or three poles versions.



## Invar Rod thermostats for temperature control

These thermostats are the oldest systems of temperature control, and the first of them was invented by French engineer Jean Simon Bonnemain in 1783. They use the differential expansion of two metals to activate a mechanism. They are widely used in storage water heaters and in boilers. Their calibration is not subject to ambient temperature variation drift such as liquid expansion bulb and capillary thermostats. They are available with control action or manual reset action. Their specificity is that the measuring rod is secured to the adjustment head and electrical contacts.

Current models, using a brass or stainless steel tube and invar rod, have measuring ranges between -50 and +400°C.



## Bulb and capillary thermostats with explosion proof electrical contacts

Built on the same mechanical basis than the standard thermostats, and achievable within the same temperature ranges, these thermostats use an explosion-proof micro switch which is a unique design concept developed by JPCI. The advantage of this system is to avoid heavy and expensive IIB or IIC metal boxes, and to allow temperature set point adjustment without need to switch off the electrical power supply. The most recent versions include an increased safety enclosure with connection block.

Electrical rating is 15A 250V, SPDT

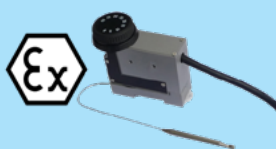



## Liquid expansion bulb and capillary cut-outs with fixed temperature setting

These devices operate on a principle similar to the liquid expansion bulb and capillary thermostats and are not adjustable. They include a reset button to close the electrical contact when it has opened after a temperature rise.

There is one variant of these cut out, with a fail-safe mechanism. It automatically opens the contacts if the capillary or bulb are leaking or cut.

The Diastat membrane is artificially inflated. Leakage causes the bursting of the membrane below its nominal thickness at room temperature, and a special mechanism will detects the abnormal displacement, which is similar to a very low ambient temperature sensing. The disadvantage of this system is that these fail-safe limiters also switch off when the ambient temperature drops below a certain value, generally between  $-10$  and  $-20^{\circ}\text{C}$ .

The artificial inflation of the membrane also greatly increased the volume of liquid it contains, thus makes them highly sensitive to temperature, with temperature drifts up to  $0.3^{\circ}\text{K}/^{\circ}\text{K}$ .

They can be used as an high limit safety device in addition to a mechanical thermostat or an electronic controller. They are available in single pole, two, three or four poles versions. They usually only have open on rise contacts.



## Liquid expansion bulb and capillary cut-outs with adjustable set point

These devices operate on the same principle as the control thermostats, but feature a reset button to close the electrical contact when it opened after a temperature rise. They can be used as an overheating safety system behind a mechanical thermostat or an electronic controller. JPCI is one of the few manufacturers offering this kind of thermostats with the same adjustment ranges than the control thermostats, and a change-over contact (which enables to signal a defect without relaying), and with ranges up to  $750^{\circ}\text{C}$ .



## Limiters bulb and capillary fixed temperature, vapor pressure (also called boiling)

These devices operate on a different principle than liquid expansion thermostat. They use a simple mechanism, invented 50 years ago by the Wilcolator company, combining the snap action of a bumped disc actuated by the huge pressure increase due to the boiling of liquid in a closed chamber. This design concept provides very simple mechanisms. Technology lies in the selection of liquids with different boiling points. Operating temperatures ranges are linked to the liquid used and its boiling temperature. Capillary length is also limited due to pressure losses induced during boiling, hindering its operation.

It is necessary that a relatively large volume of liquid is boiled to cause the membrane tripping. This is the reason why the capillary end measuring temperature is spiraled. If the capillaries are not spiraled, at least 30cm of it must be immersed in the controlled liquid. They are never adjustable and have a reset button to switch on the electrical contact when it is open as a result of an increase in temperature. As the filling is carried out under vacuum, a leak in the train thermostat triggers the mechanism. Unlike liquid filled systems sensitive to changes in temperature, they do not trigger when the temperature drops below a limit. However, they are slightly sensitive to changes in atmospheric pressure, which limits their use in altitude.

They can be used as a safety system of a mechanical thermostat behind overheating or an electronic controller. They are available with single pole, 2, 3 and 4 poles contacts. They usually have open on temperature rise contacts. Some models developed by JPCI have SPDT and DPDT contacts.



## Invar Rod thermostats with manual reset

These thermostats are the oldest systems of temperature control, and the first of them was invented by French engineer Jean Simon Bonnemain in 1783. They use the differential expansion of two metals to activate a mechanism. They are widely used in storage water heaters and in boilers. Their calibration is not subject to ambient temperature variation drift such as liquid expansion bulb and capillary thermostats. They are available with control action or manual reset action. Their specificity is that the measuring rod is secured to the adjustment head and electrical contacts.

Current models, using a brass or stainless steel tube and invar rod, have measuring ranges between  $-50$  and  $+400^{\circ}\text{C}$ .



## Failsafe bulb and capillary cut out with explosion proof switch

Built on the same mechanical base than failsafe boiling cut out, and achievable within the same temperature ranges, these thermostats use an explosion proof switch. The advantage of this system is to avoid heavy and expensive IIB or IIC explosion proof housings. The thermostat output cable connection must necessarily take place in an "increased safety" enclosure or outside the hazardous areas. The most recent versions include a built in increased safety "e" enclosure. Depending of models, electrical rating can go from 5A 250V SPDT to 15A 400V SPDT. 2 poles versions are also available.





Because of permanent improvement of our products, drawings, descriptions, features used on these data sheets are for guidance only and can be modified without prior advice



## Combined bulb and capillary thermostat/ cut-out with adjustable set points

These devices operate on the same principle as the control thermostats, but feature a double bulb, one used for the control, the other for the manual reset. They have an adjustment shaft for the control, and a manual reset button allows switch on again the safety electrical contact, when it opened after a temperature rise. The safety set point is factory fixed. The contacts are open on temperature rise only. They are mainly used in three-phase applications, although there are SPNO and DPNO versions.

There are versions of these devices with failsafe manual reset contact, but they have a strong drift when the ambient temperature of the head varies, up to 0.3°C/ °C. For example if there is a variation in ambient temperature of 10°C on the thermostat head, the set point drift can be as 3°C.



## Thermal fuses (also called TCO, for Thermal Cut Off)

The thermal fuse cut-outs are composed of a contact mechanism triggered by melting of a metal or plastic pellet. They open irreversibly an electrical contact at a given temperature. Their trigger point should be selected according to the normal operating temperature and sufficiently distant from it to avoid false triggering. Their installation is hard to perform. JPCI has developed a range of 16A 250V cut-offs which are wired and silicone insulated. They allow easy mounting in pockets.



## Blind electronic thermostats

These products, developed by JPCI, provide a bridge between the electronic controls with digital display and the electromechanical thermostats of which they keep the setting ranges, mounting, current rating, on/ off action, and with whom they are generally interchangeable. They are inexpensive, allow measurements at larger distances than the bulb and capillary thermostats. They provide a greater accuracy and the ability to adjust the contact differential.



## Electronic thermostats with digital display

These products, developed by JPCI offer an easy to use electronic solution, with a digital display. From the electromechanical thermostats, they retain the electrical rating, the ON-OFF action, and ease of use.

They are inexpensive, and they allow, in addition to displaying the measured temperature, measurements at distances larger than the bulb and capillary thermostats, greater accuracy and the ability to adjust the differential temperature.

## DC applications

For specific DC heating applications, mainly in railway systems, Ultimheat has developed contacts magnetic blowing devices. They can be applied to some models of thermostats (e.g.: disc thermostats, surface thermostat, bulb and capillary thermostats, rod thermostats), with electrical rating up to 230V DC and 16A, providing a long electrical life (exceeding 100, 000 cycles). These developments are subject of specific studies on a case by case basis.



Because of permanent improvement of our products, drawings, descriptions, features used on these data sheets are for guidance only and can be modified without prior advice



Because of permanent improvement of our products, drawings, descriptions, features used on these data sheets are for guidance only and can be modified without prior advice

# References list



Because of permanent improvement of our products, drawings, descriptions, features used on these data sheets are for guidance only and can be modified without prior advice



# References list



Because of permanent improvement of our products, drawings, descriptions, features used on these data sheets are for guidance only and can be modified without prior advice

| Reference          | Reference          | Reference        | Reference        | Reference        |
|--------------------|--------------------|------------------|------------------|------------------|
| 2DNAP6FA           | 4911NP04010DCSVM37 | 4REMRR120DBSY100 | 5MA3SPF227H19340 | 66MK****         |
| 2DNAP6FB           | 4911NP05010CL6H037 | 5MA3SPF070019340 | 5MA3SPF240019340 | 66ML****         |
| 2DNAP6FI           | 4911NP05010CL6HF39 | 5MA3SPF070F18500 | 5MA3SPF240F18500 | 66MM****         |
| 2DNAP6FJ           | 4911NP05510DL6HF37 | 5MA3SPF070H19340 | 5MA3SPF240H19340 | 66MM006000102FB  |
| 2PE2N6             | 4911NP06010CL6H037 | 5MA3SPF077019340 | 664CLR030        | 66MM0060040402FB |
| 2PE2P6             | 4911NP07010DCSV037 | 5MA3SPF077F18500 | 664CLR114        | 66MM0060040402FY |
| 2PMR100            | 4911NP07010DCSVM37 | 5MA3SPF077H19340 | 66BF1            | 66MM0060300901FB |
| 35ER101TF230V      | 4911NP07010DL6H037 | 5MA3SPF084019340 | 66BF2            | 66MM0060300901FY |
| 35ER102TF024V      | 4911NP07010DL6HF39 | 5MA3SPF084F18500 | 66BF3            | 66MM0060503001FB |
| 35ER102TF048V      | 4911NP07510DCSV037 | 5MA3SPF084H19340 | 66BR01           | 66MM0060503001FY |
| 35ER104TF400V      | 4911NP07510DCSVM37 | 5MA3SPF091019340 | 66BR02           | 66MN****         |
| 35ER105TF110V      | 4911NP08010DL6H037 | 5MA3SPF091F18500 | 66BR03           | 66MP*            |
| 4903EJ00905CCSV037 | 4911NP09015DCSVF39 | 5MA3SPF091H19340 | 66CG12**         | 66MP0060040402FW |
| 4903EJ00905CCSVM37 | 4911NP12514DL6VM37 | 5MA3SPF096019340 | 66CG5            | 66MP0060040402FX |
| 4903EJ01006CL6H0   | 4911NP15023EL6VM37 | 5MA3SPF096F18500 | 66CG5001         | 66MP0060300901FW |
| 4903EJ01006CL6MF   | 4911SU04511CL6HF39 | 5MA3SPF096H19340 | 66CP01           | 66MP0060300901FX |
| 4903EJ01006CUSV0   | 4911SU04511CL6HM37 | 5MA3SPF106019340 | 66CP02           | 66MP0060301101FW |
| 4903EJ01808CL6VM37 | 4993AJ00805HCSV0   | 5MA3SPF106F18500 | 66CP03****       | 66MP0060301101FX |
| 4903EJ04010CCSVF44 | 4993AZ00805HL6H0   | 5MA3SPF106H19340 | 66CP04****       | 66MP0060502001FW |
| 4903EJ04512CL6V037 | 4993AZ01006CL6MF   | 5MA3SPF109019340 | 66DA0008050400   | 66MP0060502001FX |
| 4903EJ04512CL6VM37 | 4C504T070RMEM60D   | 5MA3SPF109F18500 | 66D112****       | 66MP0060503001FW |
| 4903EJ05010DCSVF47 | 4C504T075RMEM60D   | 5MA3SPF109H19340 | 66DK12****       | 66MP0060503001FX |
| 4903EJ05010DL6VM39 | 4C504T080RMEM60D   | 5MA3SPF121019340 | 66DL14P****      | 66MQ             |
| 4903EJ05510DCSVF44 | 4C504T085RMEM60D   | 5MA3SPF121F18500 | 66DR12510021C000 | 66MQ****         |
| 4903EJ06010CL6HM37 | 4C504T090RMEM60D   | 5MA3SPF121H19340 | 66DU****         | 66MR****         |
| 4903EJ06010CL6VM37 | 4C504T095RMEM60D   | 5MA3SPF129019340 | 66EL****         | 66MS****         |
| 4903EJ06010DCSV037 | 4C504T100RMEM60D   | 5MA3SPF129F18500 | 66EM**           | 66MU*            |
| 4903EJ06010DCSVF34 | 4C504T105RMEM60D   | 5MA3SPF129H19340 | 66EN1            | 66MU****         |
| 4903EJ06010DCSVM37 | 4C504T110RMEM60D   | 5MA3SPF139019340 | 66EN2            | 66MV****         |
| 4903EJ06015DCSVF34 | 4C504T120RMEM60D   | 5MA3SPF139F18500 | 66EN2**          | 66MW****         |
| 4903EJ06510CL6V037 | 4C504T130RMEM60D   | 5MA3SPF139H19340 | 66EN3            | 66MZ*            |
| 4903EJ06510DCSVF47 | 4C504T140RMEM60D   | 5MA3SPF152019340 | 66EN4            | 66MZ****         |
| 4903EJ06510DL6VF39 | 4C504T150RMGM60D   | 5MA3SPF152F18500 | 66EN4**          | 66MZ.....        |
| 4903EJ07010CL6VF37 | 4C504T160RMEM60D   | 5MA3SPF152H19340 | 66EN5            | 66MZ0000010502FW |
| 4903EJ07010DCSVF34 | 4R05EJ050RMDCSV047 | 5MA3SPF165019340 | 66EN6            | 66MZ006*****     |
| 4903EJ07020DL6VM37 | 4R05EJ055RMCCSVF41 | 5MA3SPF165F18500 | 66GA2890K        | 66MZ0060000107FW |
| 4903EJ07510DCSVF34 | 4R05EJ055RMCCSVF44 | 5MA3SPF165H19340 | 66K***           | 66MZ0060000107FX |
| 4903EJ07510DCSVF44 | 4R05EJ065RMDCSVF44 | 5MA3SPF169019340 | 66KG3635*        | 66MZ0060000502FW |
| 4903EJ08016DL6HM37 | 4R05EJ070RMDCSV47  | 5MA3SPF169F18500 | 66MA****         | 66MZ0060000502FX |
| 4903EJ08818DL6VM37 | 4R05EJ075RMDCSVF44 | 5MA3SPF169H19340 | 66MB****         | 66MZ0060000602FW |
| 4903EJ09510CCSVF44 | 4R05EJ075RMDCSV47  | 5MA3SPF182019340 | 66MB0600000010MW | 66MZ0060000602FX |
| 4903EK07010CL6VM37 | 4R05EJ085RMDCSVF44 | 5MA3SPF182F18500 | 66MC****         | 66MZ0060000703FW |
| 4910NP15514EL6VM37 | 4R05EJ090RMDCSVF44 | 5MA3SPF182H19340 | 66MD****         | 66MZ0060000703FX |
| 4911NP01006CL6H0   | 4R05EJ090RMDL6VM37 | 5MA3SPF188019340 | 66MD003000071    | 66MZ0060000902FW |
| 4911NP01006CL6MF   | 4R05EJ120RMDCSVF44 | 5MA3SPF188F18500 | 66ME****         | 66MZ0060000902FX |
| 4911NP01006CUSV0   | 4R05NJ150RMEL6HM37 | 5MA3SPF188H19340 | 66MF****         | 66MZ0060040402FW |
| 4911NP03308CL6HF39 | 4REMRR055DBSY100   | 5MA3SPF216019340 | 66MF006000001    | 66MZ0060040402FX |
| 4911NP03806CCSV037 | 4REMRR065DBSY100   | 5MA3SPF216F18500 | 66MG****         | 66MZ0060040407FW |
| 4911NP03806CCSVM37 | 4REMRR075DBSY100   | 5MA3SPF216H19340 | 66MH****         | 66MZ0060040407FX |
| 4911NP03806CL6V037 | 4REMRR085DBSY100   | 5MA3SPF227019340 | 66MI****         | 66MZ0060101503FW |
| 4911NP04010DCSV037 | 4REMRR090DBSY100   | 5MA3SPF227F18500 | 66MJ****         | 66MZ0060101503FX |





Because of permanent improvement of our products, drawings, descriptions, features used on these data sheets are for guidance only and can be modified without prior advice

# Control Thermostats



Because of permanent improvement of our products, drawings, descriptions, features used on these data sheets are for guidance only and can be modified without prior advice



# Control Thermostats

## Snap action 9mm reduced thickness 1/2" disc thermostat, 10A 250V Type 4911

### Dimensions

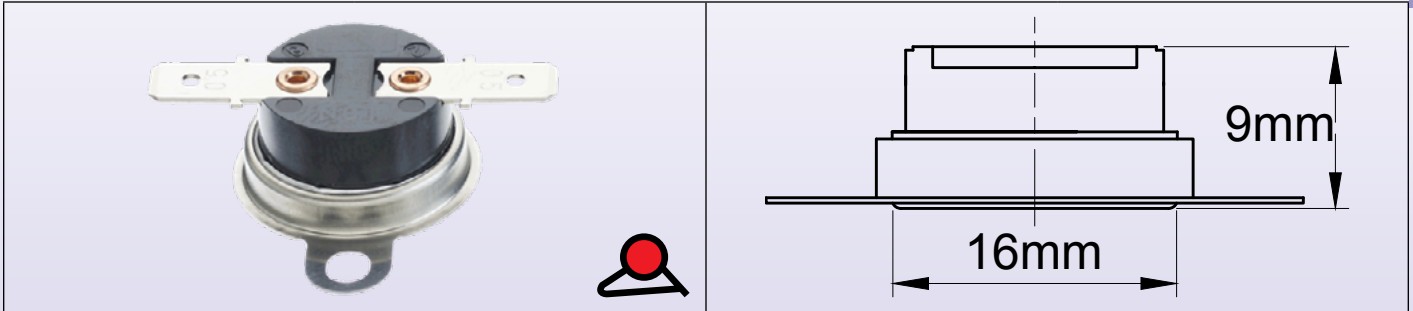

### Main bracket types

|                 |                    |                         |                           |
|-----------------|--------------------|-------------------------|---------------------------|
|                 |                    |                         |                           |
| 1<br>No bracket | 2<br>Loose bracket | 3<br>Flat fixed bracket | 4<br>Extended cup bracket |

### Main terminal types

|                                     |                        |                           |                            |
|-------------------------------------|------------------------|---------------------------|----------------------------|
|                                     |                        |                           |                            |
| A<br>6.3 vertical                   | B<br>6.3 horizontal    | C<br>4.8 vertical         | D<br>4.8 horizontal        |
|                                     |                        |                           |                            |
| E<br>Vertical solder, radius output | F<br>Horizontal solder | G<br>Open vertical solder | H<br>6.3 vertical downside |

### Angle between terminals and bracket

|     |     |     |     |
|-----|-----|-----|-----|
|     |     |     |     |
| 30° | 45° | 60° | 90° |

Because of permanent improvement of our products, drawings, descriptions, features used on these data sheets are for guidance only and can be modified without prior advice



# Control Thermostats

## Technical features

**Case:** phenolic resin (ceramic on request).

**Sensing element:** bimetal disc.

**Calibration:** factory fixed setting, from -15 to +150°C, 5 to 302°F (200°C, 392°F with ceramic body). Not adjustable. Standard calibration tolerances  $\pm 4^\circ\text{C}$  to  $\pm 6^\circ\text{C}$ ,  $\pm 39.2^\circ\text{F}$  to  $42.8^\circ\text{F}$  upon models.

**Terminals:** 6.3 or 4.8 quick connect, or welding terminals.

**Differential:** factory set, from 10°C to 25°C, 50°F to 77°F

**Mounting:** with or without bracket.

**Main bracket models:**

- Loose bracket, two oval holes 3.2 × 3.5, for M3 screws, 24.5mm distance.
- Flat fixed bracket, two oval holes 3.2 × 3.5, for M3 screws, 24.5mm distance.
- Flat cup bracket, two oval holes 3.2 × 4.2, for M3 screws, 24mm distance.
- M4 or M5 center stud on request.

**Cap materials:** stainless steel (SS) or aluminum (AL).

**Ratings:** 15A 125VAC, 10A 240VAC

## Main references (usually available from stock\*)

| References            | Open**<br>°C/ °F | Tolerance<br>$\pm^\circ\text{C}/ \pm^\circ\text{F}$ | Close °C/ °F | Tolerance<br>$\pm^\circ\text{C}/ \pm^\circ\text{F}$ | Bracket Nr | Bracket material | Terminal Nr | Angle terminal- bracket |
|-----------------------|------------------|---|--------------|---|------------|------------------|-------------|-------------------------|
| 4911NP03308CL6HF39    | 33/ 91.4         | 3/ 37.4   | 25/ 77       | 4/ 39.2   | 4          | AL               | B           | 90                      |
| 4911SU04511CL6HF39    | 34/ 93.2         | 3/ 37.4   | 45/ 113      | 4/ 39.2   | 4          | AL               | B           | 90                      |
| 4911SU04511CL6HM37    | 34/ 93.2         | 3/ 37.4   | 45/ 113      | 4/ 39.2   | 2          | AL               | B           | N/A                     |
| 4911NP03806CL6V037    | 38/ 100.4        | 3/ 37.4   | 32/ 89.6     | 4/ 39.2   | 1          | AL               | A           | N/A                     |
| 4911NP03806CCSV037    | 38/ 100.4        | 3/ 37.4   | 32/ 89.6     | 4/ 39.2   | 1          | AL               | E           | N/A                     |
| 4911NP03806CCSVM37    | 38/ 100.4        | 3/ 37.4   | 32/ 89.6     | 4/ 39.2   | 2          | AL               | E           | N/A                     |
| 4911NP04010DCSV037    | 40/ 104          | 3/ 37.4   | 30/ 86       | 4/ 39.2   | 1          | AL               | E           | N/A                     |
| 4911NP04010DCSVM37    | 40/ 104          | 3/ 37.4   | 30/ 86       | 4/ 39.2   | 2          | AL               | E           | N/A                     |
| 4911NP05010CL6HF39    | 50/ 122          | 3/ 37.4   | 40/ 104      | 4/ 39.2   | 4          | AL               | B           | 90                      |
| 4911NP05010CL6H037    | 50/ 122          | 3/ 37.4   | 40/ 104      | 4/ 39.2   | 1          | AL               | B           | N/A                     |
| 4911NP05510DL6HF37    | 55/ 131          | 4/ 39.2   | 45/ 113      | 5/ 41   | 4          | AL               | B           | 90                      |
| 4911NP06010CL6H037    | 60/ 140          | 3/ 37.4   | 50/ 122      | 4/ 39.2   | 1          | AL               | B           | N/A                     |
| 4911NP07010DL6H037    | 70/ 158          | 4/ 39.2   | 60/ 140      | 5/ 41   | 1          | AL               | B           | N/A                     |
| 4911NP07010DL6HF39    | 70/ 158          | 4/ 39.2   | 60/ 140      | 5/ 41   | 4          | AL               | B           | 90                      |
| 4911NP07010DCSV037    | 70/ 158          | 4/ 39.2   | 60/ 140      | 5/ 41   | 1          | AL               | E           | N/A                     |
| 4911NP07010DCSVM37    | 70/ 158          | 4/ 39.2   | 60/ 140      | 5/ 41   | 2          | AL               | E           | N/A                     |
| 4911NP07510DCSV037    | 75/ 167          | 4/ 39.2   | 65/ 149      | 5/ 41   | 1          | AL               | E           | N/A                     |
| 4911NP07510DCSVM37    | 75/ 167          | 4/ 39.2   | 65/ 149      | 5/ 41   | 2          | AL               | E           | N/A                     |
| 4911NP08010DL6H037    | 80/ 176          | 3/ 37.4   | 70/ 158      | 4/ 39.2   | 1          | AL               | B           | N/A                     |
| 4911NP09015DCSVF39    | 90/ 194          | 4/ 39.2   | 75/ 167      | 5/ 41   | 4          | AL               | E           | 90                      |
| 4911NP12514DL6VM37    | 125/ 257         | 5/ 41   | 111/ 231.8   | 6/ 42.8   | 2          | AL               | A           | N/A                     |
| 4911NP15023EL6VM37    | 150/ 302         | 6/ 42.8   | 141/ 285.8   | 7/ 44.6   | 2          | AL               | A           | N/A                     |
| 4910NP15514EL6VM37*** | 155/ 311         | 6/ 42.8   | 141/ 285.8   | 7/ 44.6   | 2          | AL               | A           | N/A                     |

\* Products usually available from stock in one of the Ultimheat Alliance members.

\*\* Temperature in red= close on rise model.

\*\*\* Ceramic body.

**These thermostats can be fitted inside various housings, overmolded and wired.  
Some examples:**

|   |   |   |   |   |   |  |   |   |   |
|---|---|---|---|---|---|--|---|---|---|
|  |  |  |  |  |  |  |  |  |  |
| Dia 18mm tubular pocket   | Waterproof tube mounting  | Waterproof, with electrical contact protection                                      | Waterproof, with M6 thread  | Waterproof, 1/2" fitting  | Waterproof, M20 fitting   | Waterproof, Cnomo connector  | Waterproof, automotive connector  | Pipe mounting with connection box   | Cable output, with flexible boot  |



# Control Thermostats

Snap action bimetal disc thermostat, 1/2" disc. 12mm thickness, 16A  
250V, **Type 4903**

## Dimensions

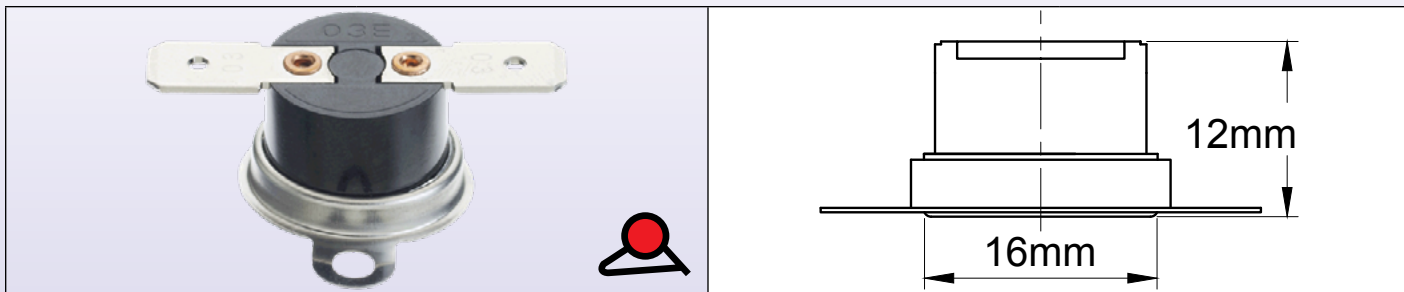

## Main bracket types

|                 |                    |                         |                           |
|-----------------|--------------------|-------------------------|---------------------------|
|                 |                    |                         |                           |
| 1<br>No bracket | 2<br>Loose bracket | 3<br>Flat fixed bracket | 4<br>Extended cup bracket |

## Main terminal types

|                                     |                        |                           |                            |
|-------------------------------------|------------------------|---------------------------|----------------------------|
|                                     |                        |                           |                            |
| A<br>6.3 vertical                   | B<br>6.3 horizontal    | C<br>4.8 vertical         | D<br>4.8 horizontal        |
|                                     |                        |                           |                            |
| E<br>Vertical solder, radius output | F<br>Horizontal solder | G<br>Open vertical solder | H<br>6.3 vertical downside |

## Angle between terminals and bracket

|     |     |     |     |
|-----|-----|-----|-----|
|     |     |     |     |
| 30° | 45° | 60° | 90° |

Because of permanent improvement of our products, drawings, descriptions, features used on these data sheets are for guidance only and can be modified without prior advice

# Control Thermostats



## Technical features

**Case:** phenolic resin (ceramic on request).

**Sensing element:** bimetal disc.

**Calibration:** factory fixed setting, from 15°C to 150°C, 5 to 302°F (200°C, 392°F with ceramic body). Not adjustable. Standard calibration tolerances  $\pm 4^\circ\text{C}$  to  $\pm 6^\circ\text{C}$ ,  $\pm 39.2^\circ\text{F}$  to  $42.8^\circ\text{F}$  upon models.

**Terminals:** 6.3 or 4.8 quick connect, or welding terminals.

**Differential:** factory set, from 10°C to 25°C, 50°F to 77°F.

**Mounting:** with or without bracket.

**Main Bracket models:**

- Loose bracket, two oval holes 3.2 × 3.5, for M3 screws, 24.5mm distance.
- Flat fixed bracket, two oval holes 3.2 × 3.5, for M3 screws, 24.5mm distance.
- Flat cup bracket, two oval holes 3.2 × 3.5, for M3 screws, 24.5mm distance
- M4 or M5 center stud on request.

**Cap materials:** stainless steel (SS) or aluminum (AL).

**Ratings:**

**UL:** AC120V/ 15A, AC240V/ 10A

**CSA:** AC 125V/ 15A, AC250V/ 8A

**VDE:** AC 250V/ 16A

## Main references (usually available from stock\*)

| References         | Open**<br>°C/ °F | Tolerance<br>$\pm^\circ\text{C}/ \pm^\circ\text{F}$ | Close °C/ °F | Tolerance<br>$\pm^\circ\text{C}/ \pm^\circ\text{F}$ | Bracket<br>Nr | Bracket<br>material | Terminal<br>Nr | Angle<br>terminal-<br>bracket |
|--------------------|------------------|---|--------------|---|---------------|---------------------|----------------|-------------------------------|
| 4903EJ00905CCSV037 | 10/ 50           | 3/ 37.4   | 5/ 41        | 4/ 39.2   | 1             | AL                  | E              | N/ A                          |
| 4903EJ00905CCSVM37 | 10/ 50           | 3/ 37.4   | 5/ 41        | 4/ 39.2   | 2             | AL                  | E              | N/ A                          |
| 4903EJ01808CL6VM37 | 18/ 64.4         | 3/ 37.4   | 10/ 50       | 4/ 39.2   | 2             | AL                  | A              | N/ A                          |
| 4903EJ04010CCSVF44 | 40/ 104          | 3/ 37.4   | 30/ 86       | 3/ 37.4   | 4             | SS                  | G              | 45°                           |
| 4903EJ04512CL6V037 | 45/ 113          | 3/ 37.4   | 33/ 91.4     | 4/ 39.2   | 1             | AL                  | A              | N/ A                          |
| 4903EJ04512CL6VM37 | 45/ 113          | 3/ 37.4   | 33/ 91.4     | 4/ 39.2   | 2             | AL                  | A              | N/ A                          |
| 4903EJ05010DL6VM39 | 50/ 122          | 4/ 39.2   | 40/ 104      | 5/ 41   | 2             | AL                  | A              | 90°                           |
| 4903EJ05010DCSVF47 | 50/ 122          | 4/ 39.2   | 40/ 104      | 3/ 37.4   | 1             | SS                  | G              | N/ A                          |
| 4903EJ05510DCSVF44 | 55/ 131          | 4/ 39.2   | 45/ 113      | 3/ 37.4   | 4             | SS                  | G              | 45°                           |
| 4903EJ06010CL6HM37 | 60/ 140          | 4/ 39.2   | 50/ 122      | 5/ 41   | 2             | AL                  | B              | N/ A                          |
| 4903EJ06010CL6VM37 | 60/ 140          | 4/ 39.2   | 50/ 122      | 5/ 41   | 2             | AL                  | A              | N/ A                          |
| 4903EJ06010DCSV037 | 60/ 140          | 4/ 39.2   | 50/ 122      | 5/ 41   | 1             | AL                  | E              | N/ A                          |
| 4903EJ06010DCSVM37 | 60/ 140          | 4/ 39.2   | 50/ 122      | 5/ 41   | 2             | AL                  | E              | N/ A                          |
| 4903EK07010CL6VM37 | 60/ 140          | 4/ 39.2   | 70/ 158      | 5/ 41   | 2             | AL                  | A              | N/ A                          |
| 4903EJ06010DCSVF34 | 60/ 140          | 4/ 39.2   | 50/ 122      | 3/ 37.4   | 4             | AL                  | G              | 45°                           |
| 4903EJ06015DCSVF34 | 60/ 140          | 4/ 39.2   | 45/ 113      | 4/ 39.2   | 4             | AL                  | G              | 45°                           |
| 4903EJ06510CL6V037 | 65/ 149          | 4/ 39.2   | 55/ 131      | 5/ 41   | 1             | AL                  | A              | N/ A                          |
| 4903EJ06510DL6VF39 | 65/ 149          | 4/ 39.2   | 55/ 131      | 5/ 41   | 4             | AL                  | A              | 90°                           |
| 4903EJ06510DCSVF47 | 65/ 149          | 4/ 39.2   | 55/ 131      | 3/ 37.4   | 1             | SS                  | G              | N/ A                          |
| 4903EJ07020DL6VM37 | 70/ 158          | 4/ 39.2   | 50/ 122      | 5/ 41   | 2             | AL                  | A              | N/ A                          |
| 4903EJ07010CL6VF37 | 70/ 158          | 4/ 39.2   | 60/ 140      | 5/ 41   | 4             | AL                  | A              | 90°                           |
| 4903EJ07010DCSVF34 | 70/ 158          | 4/ 39.2   | 60/ 140      | 3/ 37.4   | 4             | AL                  | G              | 45°                           |
| 4903EJ07510DCSVF44 | 75/ 167          | 4/ 39.2   | 65/ 149      | 3/ 37.4   | 4             | SS                  | G              | 45°                           |
| 4903EJ07510DCSVF34 | 75/ 167          | 4/ 39.2   | 65/ 149      | 3/ 37.4   | 4             | AL                  | G              | 45°                           |
| 4903EJ08016DL6HM37 | 80/ 176          | 4/ 39.2   | 64/ 147.2    | 5/ 41   | 2             | AL                  | B              | N/ A                          |
| 4903EJ08818DL6VM37 | 88/ 190.4        | 4/ 39.2   | 70/ 158      | 5/ 41   | 2             | AL                  | A              | N/ A                          |
| 4903EJ09510CCSVF44 | 95/ 203          | 3/ 37.4   | 85/ 185      | 3/ 37.4   | 4             | SS                  | G              | 45°                           |

\* Products usually available from stock in one of the Ultimheat Alliance members.

\*\* Temperature in red= close on rise model.

**These thermostats can be fitted inside various housings, overmolded and wired.  
Some examples:**

|                          |                          |  |   |                          |                         |                             |                                  |                                   |                                  |
|--------------------------|--------------------------|--|---|--------------------------|-------------------------|-----------------------------|----------------------------------|-----------------------------------|----------------------------------|
|                          |                          |  |   |                          |                         |                             |                                  |                                   |                                  |
| Dia. 18mm tubular pocket | Waterproof tube mounting | Waterproof, with electrical contact protection | Waterproof, epoxy resin potted, 2 thermostats with the same bracket | Waterproof, 1/2" fitting | Waterproof, M20 fitting | Waterproof, Cnomo connector | Waterproof, automotive connector | Pipe mounting with connection box | Cable output, with flexible boot |





# Control Thermostats

## Selection of defrost or antifreeze protection disc thermostats

### Thermostats for RTV silicone potting

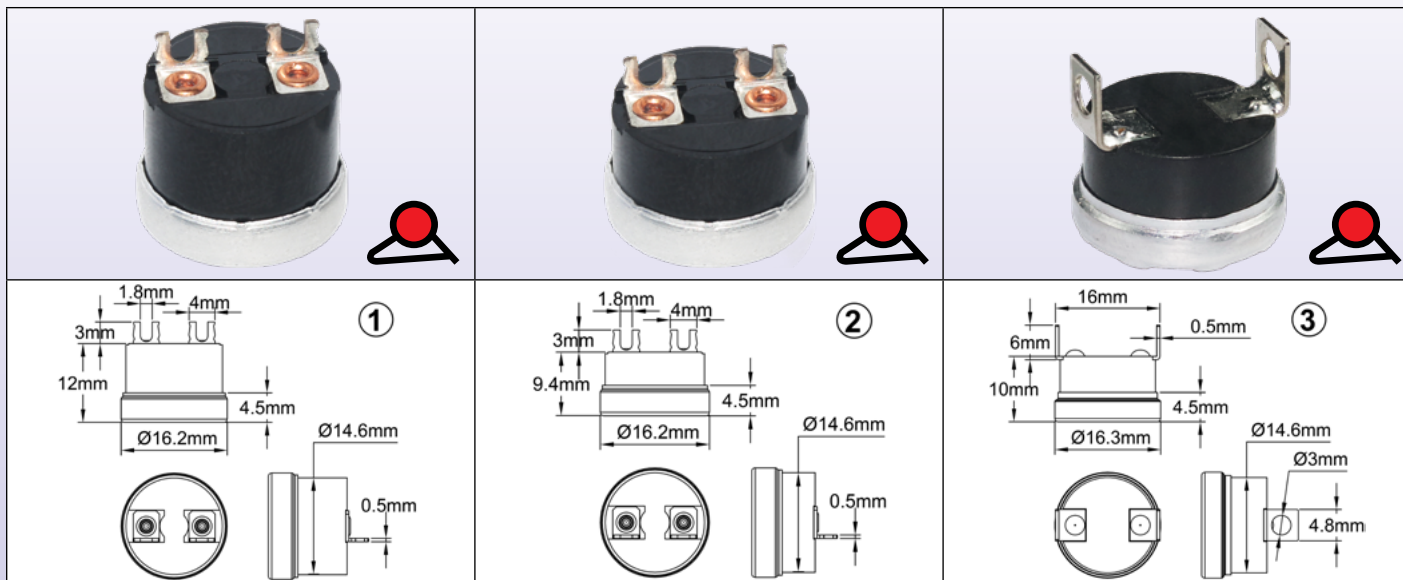

This disc thermostat is adapted to cable end mounting, with small size solder terminals and aluminum cup. It withstands silicone or epoxy filling. Thermostat opens on temperature rise.

| References       | Open °C(°F)        | Close °C(°F)      | Rating (250VAC) | Type |
|------------------|--------------------|-------------------|-----------------|------|
| 4903EJ01006CUSVO | 10±3(50±37.4°F)    | 4±3(39.2±37.4°F)  | 16A             | 1    |
| 4911NP01006CUSVO | 10±3(50±37.4°F)    | 4±3(39.2±37.4°F)  | 10A             | 2    |
| 4993AJ00805HCSV0 | 8±2.5(46.4±36.5°F) | 3±2.5(7.4±36.5°F) | 8A *            | 3    |

\* Other set points, terminals or brackets: contact us.

### Thermostat for end of cable connection, protection by shrinkable sleeve

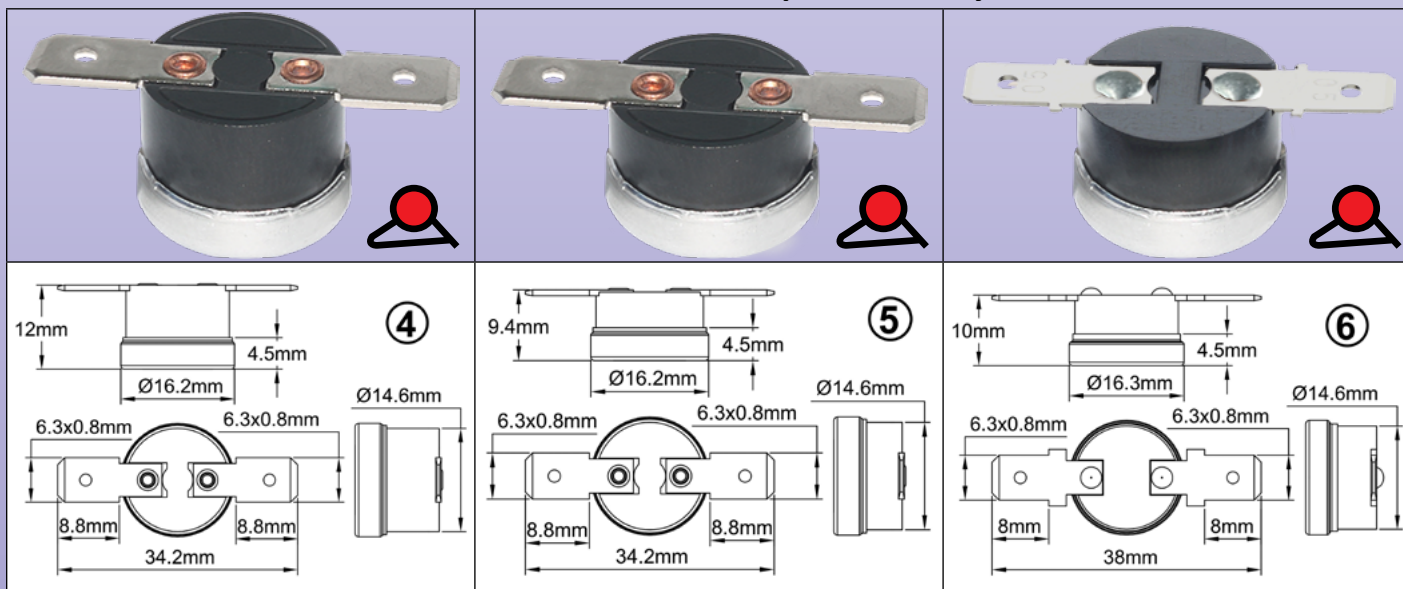

Anti-freeze thermostat, for mounting on heating cable end under double wall shrinkable sleeve, with 6.3 × 0.8 horizontal tab terminals, for fast-on connectors or soldering. Aluminum temperature sensing cup. Contact opens on temperature rise.

| References       | Open °C(°F)       | Close °C(°F)       | Rating (250VAC) | Type |
|------------------|-------------------|--------------------|-----------------|------|
| 4903EJ01006CL6H0 | 10±3 (50±37.4°F)  | 4±3 (39.2±37.4°F)  | 16A             | 4    |
| 4911NP01006CL6H0 | 10±3 (50±37.4°F)  | 4±3 (39.2±37.4°F)  | 10A             | 5    |
| 4993AZ00805HL6H0 | 8±3 (46.4±36.5°F) | 3±2.5 (7.4±36.5°F) | 8A *            | 6    |

\* Other set points, terminals or brackets: contact us.

Because of permanent improvement of our products, drawings, descriptions, features used on these data sheets are for guidance only and can be modified without prior advice



# Control Thermostats

## Antifreeze thermostat, through wall mounting

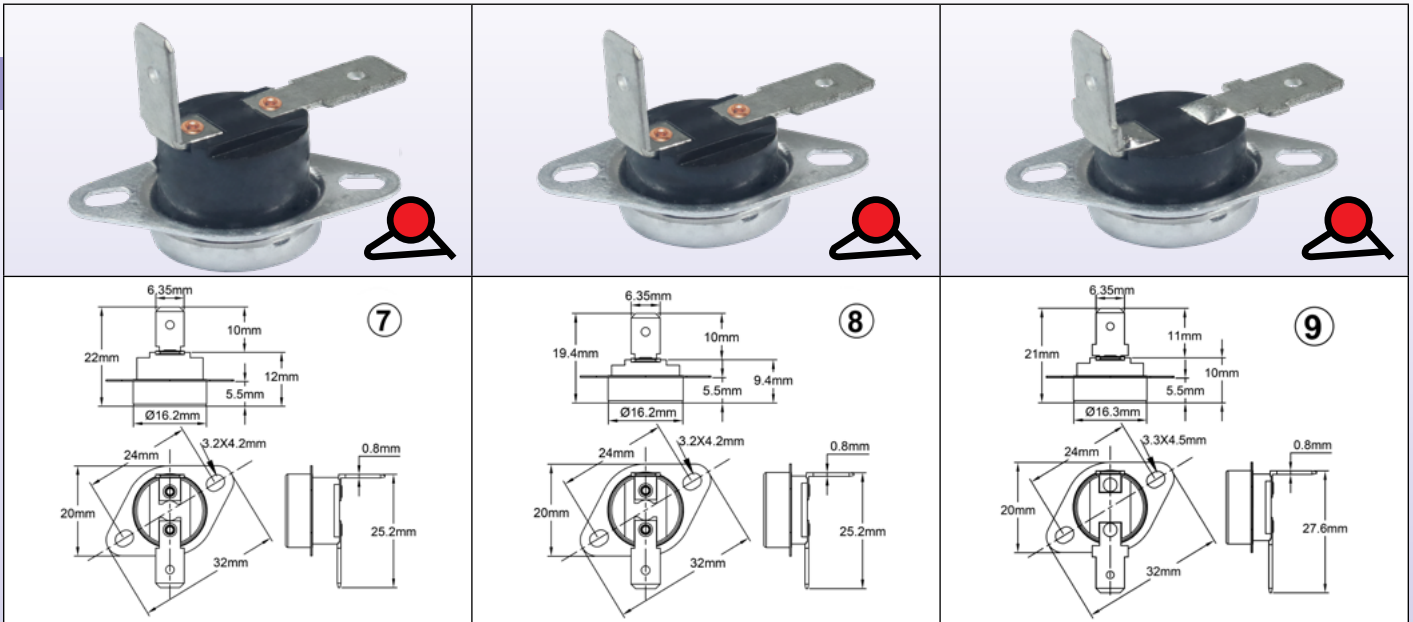

**Anti-freeze thermostat, for through wall mounting on junction or connection boxes, 6.3 × 0.8 tab terminals.** Aluminum temperature sensing extended cup. Contact opens on temperature rise. The temperature sensing part of the thermostat is located outside the box, and the electrical connection remains inside. Hole drill: dia 16.4mm.

| References       | Open °C(°F)       | Close °C(°F)       | Rating (250VAC) | Type |
|------------------|-------------------|--------------------|-----------------|------|
| 4903EJ01006CL6MF | 10±3 (50±37.4°F)  | 4±3 (39.2±7.4°F)   | 16A             | 7    |
| 4911NP01006CL6MF | 10±3 (50±37.4°F)  | 4±3 (39.2±7.4°F)   | 10A             | 8    |
| 4993AZ01006CL6MF | 8±3 (46.4±36.5°F) | 3±2.5 (7.4±36.5°F) | 8A *            | 9    |

Other set points, terminals or brackets: contact us.

\* 8A 250V 100000 cycles, 10A 250V, 20,000 cycles.

**These thermostats can be fitted inside various housings. Some have been specially designed for freeze protection**

|                                  |                          |  |   |   |  |  |   |                                   |   |
|----------------------------------|--------------------------|--|---|---|--|--|---|-----------------------------------|---|
|                                  |                          |  |   |   |  |  |   |                                   |   |
| Dia 18mm aluminum tubular pocket | Waterproof tube mounting | Waterproof, with electrical contact protection | Waterproof, over-molded silicone boot, for heat tracing line and flat vacle | Waterproof, over-molded silicone boot, on electrical cord end | Waterproof, M20 × 1.5 fitting, mounting at ISO cable gland place | Waterproof, wall mounting connection box | Waterproof, plastic housing, cable output | Pipe mounting with connection box | Cable output, with flexible silicone boot |



# Control Thermostats

## Technical over-molding of thermostats

### Type 49JE

#### Dimensions

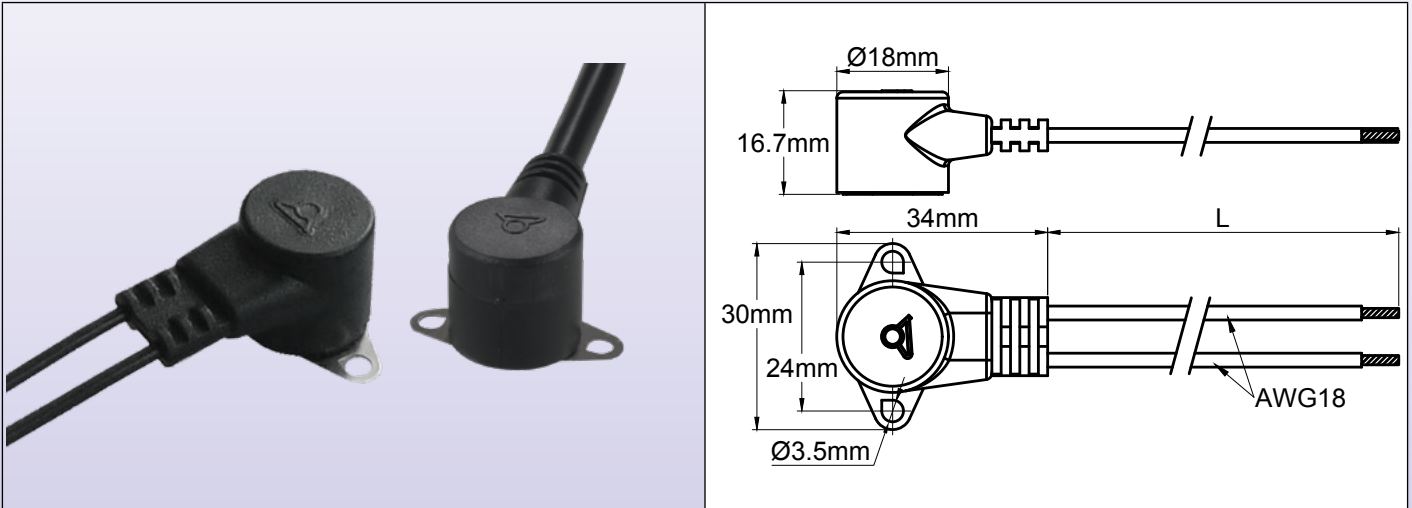

#### Technical features

The assembly is waterproof, frost proof, short immersion proof, protects the connection of the power cord to the thermostat, protects the thermostat housing and is terminate the defrost when the temperature rise to a warm temperature. The thermostat is mounted on a heat exchanger or on a pipe, with its sensitive disc located thereon. He is secured there with a spring or with a bracket.

The temperature sensitive cup is made in stainless steel and is not covered by the over-molding, to optimize the temperature measurement and the response time.

This type of assembly is cost saving, but requires MOQ of 500 pieces.

**The designs and quotations of this product are only made on the basis of customer's specs, and depend on the thermostat open and close temperatures, and type, gauge and length of the cord.**

Because of permanent improvement of our products, drawings, descriptions, features used on these data sheets are for guidance only and can be modified without prior advice



# Control Thermostats

## Surface mounting thermostats, Type IB

### Dimensions

|                                  |                        |                                    |                          |
|----------------------------------|------------------------|------------------------------------|--------------------------|
|                                  |                        |                                    |                          |
|                                  |                        |                                    |                          |
| Long shaft with mounting bracket | Long shaft, no bracket | Screw adjust with mounting bracket | Screw adjust, no bracket |

### Technical features

**Applications:** precise and adjustable surface temperature control on heating plates, silicone heating pads, foil heaters.

**Housing dimensions:** 58.5 × 17.5 × 17.5mm (shaft and bracket not included).

**Material:** metal/ ceramic housing.

**Temperature sensing element:** high conductivity copper alloy.

**Terminals:** 2 × #6-32 screw terminals.

**Adjustment:** dia. 6.35mm round shaft, 32mm length, 310° mechanical rotation, or screw adjustment (other lengths, rotation or fixed setting available on request).

**Mounting:**

- Without bracket or with surface mounting bracket,
- 2 holes dia. 3.4mm, 65.5mm distance.

**Rating:** 1500 watts 110/ 250VAC, resistive (Slow make and break action).

**Contact:** open on temperature rise only.

**Differential:** lower than 1°C.

**Max ambient temperature on housing:** 300°C.

**Accessories:** knobs

**Approval:** comply with UL 873 standard (limit or control).

### Main references

| References       | Shaft length (L) | Bracket | High stop Temperature calibration °C (°F) | Approx. temperature span between min. and max. position °C (°F) |
|------------------|------------------|---------|---|---|
| IBJ2000608313001 | Screw adjustment | No      | 150 (300)                                 | 160 (290)   |
| IBJ2000608316002 | Screw adjustment | No      | 315 (600)                                 | 330 (590)   |
| IBK2000608313001 | Screw adjustment | Yes     | 150 (300)                                 | 160 (290)   |
| IBK2000608316002 | Screw adjustment | Yes     | 315 (600)                                 | 330 (590)   |
| IBJ2000632313001 | 32mm             | No      | 150 (300)                                 | 160 (290)   |
| IBJ2000632315302 | 32mm             | No      | 275 (530)                                 | 330 (590)   |
| IBJ2000632316002 | 32mm             | No      | 315 (600)                                 | 330 (590)   |
| IBK2000632313001 | 32mm             | Yes     | 150 (300)                                 | 160 (290)   |
| IBK2000632315302 | 32mm             | Yes     | 275 (530)                                 | 330 (590)   |
| IBK2000632316002 | 32mm             | Yes     | 315 (600)                                 | 330 (590)   |

### Knob

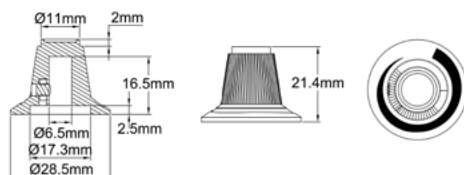

For 6.35mm diameter shaft, black PPS, white crescent. Max temperature on knob 200°C/ 392°F

Reference 66MB0600000010MW

Other knobs that fit this type: see last section of this catalogue.



# Control Thermostats

## Energy regulators, 6mm shaft, bush mounting:

### Type 35ER

#### Dimensions

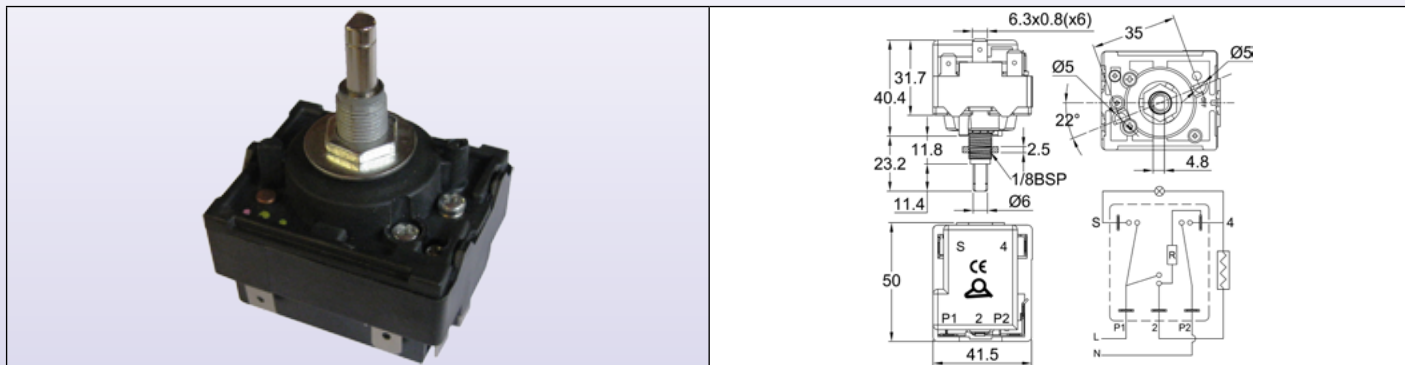

#### Technical features

##### Main features:

Energy regulators are used to adjust power on electrical heaters. Connected in line with electrical heaters, they provide adjustable cycling sequence, thus adjusting average electrical power.

**Housing dimensions:** 50 × 42 × 39mm (shaft not included.)

**Housing material:** high temperature resistant PPS.

**Terminals:** 6.3 × 0.8 quick connect.

**Adjustment:** dia. 6mm with 4.8 flat shaft, length 11.4mm (UK style models with 4.75mm dia. shaft available on request, MOQ apply).

##### Angulation:

- Mechanical: 360°, with two pole off position at 0°.

- Electrical: min position at 75° angular, Max position at 285° angular. (Other angulation with max at 208.5° available on request, MOQ apply).

**Mounting:** center ¼ BSP bush with centering studs. 2 M4, 28mm distance screws mounting bracket available on request (MOQ apply).

**Rating:** 12A 230V resistive, SPDT+ on off pilot contact. Other contact configuration (SPST, SPDT without pilot, double circuit etc... are available on request, MOQ apply).

**Max ambient temperature:** 125°C/ 257°F

**Approval:** CE

#### References

|      |               |
|------|---------------|
| 24V  | 35ER102TF024V |
| 48V  | 35ER102TF048V |
| 110V | 35ER105TF110V |
| 230V | 35ER101TF230V |
| 400V | 35ER104TF400V |

#### Knobs and dials

|   |  |   |
|---|--|---|
|   |  |   |
| Black polyamid knob with white printing | Black polyamid knob with white arrow, for anodized aluminum dial | Anodized aluminum dial with 0-100 printing for arrow knob |
| Reference 66MD003000071                 | Reference 66MF006000001  | Reference 66CG5001  |

Because of permanent improvement of our products, drawings, descriptions, features used on these data sheets are for guidance only and can be modified without prior advice



# Control Thermostats

## Single pole control thermostat, bulb and capillary

### Type 8G

2016 improvements:

- New temperature range,
- Reduced differential,
- Ground terminal,
- Power rating up to 20A 250V,
- Aligned terminals, compatible with 3 way connectors.

### Dimensions

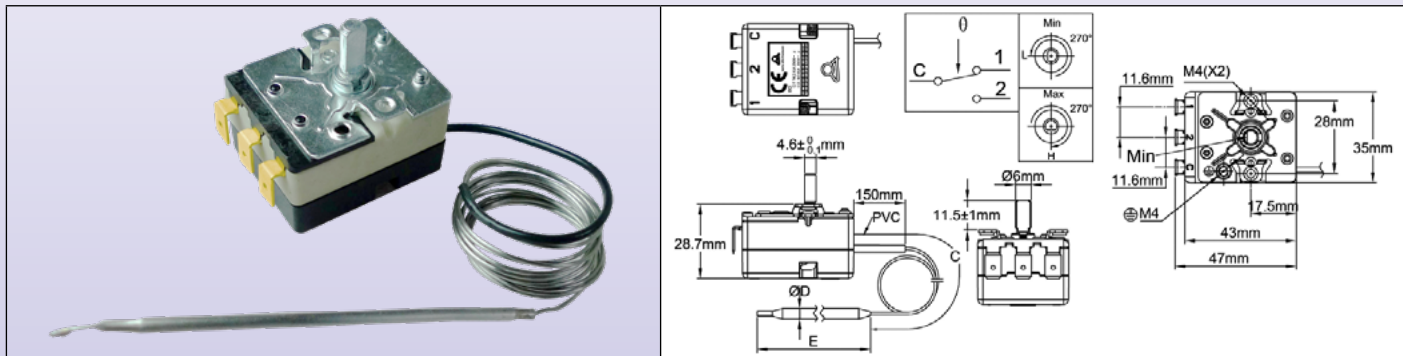

### Technical features

**Housing dimensions:** 43 × 35 × 29mm (without terminals)

**Bulb and capillary:** stainless steel, with 150mm long PVC sleeve on the capillary. Capillary minimum bending radius is 5mm. No capillary sleeve for temperature ranges above 400°C (750°F).

**Temperature sensing element:** oil filled bulb and capillary.

**Caution:** temperature ranges above 400°C (750°F) are filled with sodium-potassium eutectic. In case of breakage of the bulb or capillary, this liquid may self-ignite at room temperature in the presence of water or moisture.

**Terminals:** 6.35 × 0.8 quick connect terminals, 90° bended. Straight terminals or terminals with M4 screws also available on request. (MOQ apply). Terminal positions and alignment allow the use of a connector with flat or bended terminals.

**Adjustment:** dia. 6mm shaft with 4.6mm flat, length 11.5mm. Other lengths, screw driver adjustment or fixed setting available on request.

**Mounting:** front bracket with 2 × M4 threads, 28mm distance.

**Grounding:** M4 thread on mounting bracket.

**Contact:** SPDT

**Electrical rating, resistive loads:**

- **Open on temperature rise contact (C-1)**

16A 250V, 50 ~60Hz: >100000 cycles,

20A 250V, 50 ~60Hz: ≥ 50000 cycles,

10A 400V, 50 ~60Hz: ≥ 50000 cycles.

- **Close on temperature rise contact (C-2):** 6A 250V 50 ~60Hz: >100000 cycles

**Electrical rating, inductive loads:**

- Open on temperature rise contact (C-1): 6A 250V, 50 ~60Hz: >100000 cycles

- Close on temperature rise contact (C-2): 0.6A 250V 50 ~60Hz: >100000 cycles

### Main references

| Reference        | Temperature range °C (°F) | Capillary length(C, mm) | Bulb diameter (D, mm)         | Bulb length (E, mm) | Differential °C (°F) | Max temperature on bulb °C (°F) |
|------------------|---------------------------|-------------------------|-------------------------------|---------------------|----------------------|---------------------------------|
| 8GB-35035AO60001 | -35+35°C (-30+95°F)       | 1500                    | 6                             | 120±5               | 1.6±1°C (2.9±2°F)    | 60°C (140°F)                    |
| 8GB-35035AA60001 | -35+35°C (-30+95°F)       | 250                     | 6                             | 120±5               | 1.6±1°C (2.9±2°F)    | 60°C (140°F)                    |
| 8GB-10040AO60001 | -10+40°C (15-105°F)       | 1500                    | 6                             | 107±5               | 1.5±1°C (2.7±2°F)    | 70°C (158°F)                    |
| 8GB-10040AA60001 | -10+40°C (15-105°F)       | 250                     | 6                             | 107±5               | 1.5±1°C (2.7±2°F)    | 70°C (158°F)                    |
| 8GB004040AQ30001 | 4-40°C (40-105°F)         | 250                     | Pig tail style, dia.30mm coil | 55±10               | 1±0.5°C (1.8±1°F)    | 70°C (158°F)                    |
| 8GB004040AA80001 | 4-40°C (40-105°F)         | 250                     | 8                             | 85±5                | 1±0.5°C (1.8±1°F)    | 70°C (158°F)                    |
| 8GB004040AO60001 | 4-40°C (40-105°F)         | 1500                    | 6                             | 120±5               | 1±0.5°C (1.8±1°F)    | 70°C (158°F)                    |
| 8GB004040AA60001 | 4-40°C (40-105°F)         | 250                     | 6                             | 120±5               | 1±0.5°C (1.8±1°F)    | 70°C (158°F)                    |
| 8GB000060AO60001 | 0-60°C (32-140°F)         | 1500                    | 6                             | 86±5                | 2.5±1°C (4.5±1.8°F)  | 80°C (176°F)                    |
| 8GB000060AA80001 | 0-60°C (32-140°F)         | 250                     | 8                             | 63±5                | 2.5±1°C (4.5±1.8°F)  | 80°C (176°F)                    |



# Control Thermostats

Because of permanent improvement of our products, drawings, descriptions, features used on these data sheets are for guidance only and can be modified without prior advice

| Reference        | Temperature range °C (°F) | Capillary length (C, mm) | Bulb diameter (D, mm) | Bulb length (E, mm) | Differential °C (°F) | Max temperature on bulb °C (°F) |
|------------------|---------------------------|--------------------------|-----------------------|---------------------|----------------------|---------------------------------|
| 8GB000090AO60001 | 0-90°C (32-195°F)         | 1500                     | 6                     | 98±5                | 2.5±1°C (4.5±1.8°F)  | 120°C (250°F)                   |
| 8GB030090AO60001 | 30-90°C (85-195°F)        | 1500                     | 6                     | 98±5                | 2.5±1°C (4.5±1.8°F)  | 120°C (250°F)                   |
| 8GB030090AA80001 | 30-90°C (85-195°F)        | 250                      | 8                     | 63±5                | 2.5±1°C (4.5±1.8°F)  | 120°C (250°F)                   |
| 8GB030110AO60001 | 30-110°C (85-230°F)       | 1500                     | 6                     | 86±5                | 2.5±1°C (4.5±1.8°F)  | 140°C (284°F)                   |
| 8GB030110AA80001 | 30-110°C (85-230°F)       | 250                      | 8                     | 55±5                | 2.5±1°C (4.5±1.8°F)  | 140°C (284°F)                   |
| 8GB050200AO60001 | 50-200°C (120-390°F)      | 1500                     | 6                     | 65±5                | 4±2°C (7±3.6°F)      | 230°C (446°F)                   |
| 8GB050300AO30001 | 50-300°C (120-570°F)      | 1500                     | 3                     | 145±5               | 10°C±2°C (18±3.6°F)  | 330°C (626°F)                   |
| 8GB100400AO30001 | 100-400°C (210-750°F)     | 1500                     | 3                     | 93±5                | 10°C±2°C (18±3.6°F)  | 430°C (800°F)                   |
| 8GB100500AE40000 | 100-500°C (210-930°F)     | 500                      | 4                     | 235±5               | 10°C±2°C (18±3.6°F)  | 550°C (1000°F)                  |
| 8GB100500AG40000 | 100-500°C (210-930°F)     | 750                      | 4                     | 235±5               | 10°C±2°C (18±3.6°F)  | 550°C (1000°F)                  |
| 8GB100500AN40000 | 100-500°C (210-930°F)     | 1400                     | 4                     | 235±5               | 10°C±2°C (18±3.6°F)  | 550°C (1000°F)                  |

Other temperature ranges available on request.

**Capillary stuffing box with flat fiber gasket and M14 nut. Silicone seal. Nickel plated brass body. Max temperature 220°C.**

**3 way connector. Exists unassembled, with female terminals non-crimped, or assembled, with crimped wires, length, gauge and style upon customer request.**

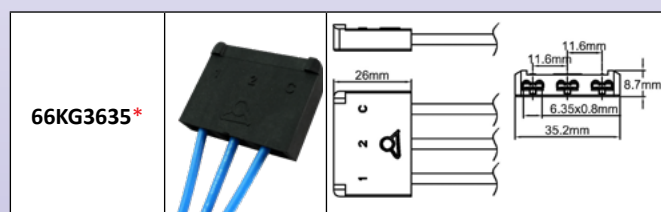
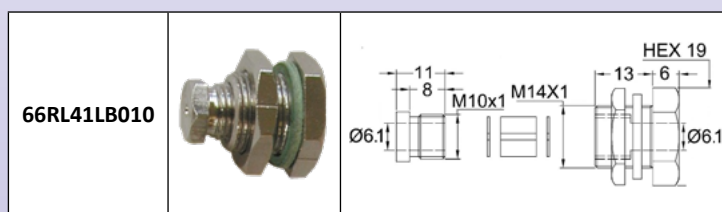

\* The 16 character full reference is issued upon customer wire types and length specs.

Many other accessories are available: pockets, flanges, fittings: see the full list in catalogue #1.

## Usual knobs and bezels.

°C Printing

|                  |                  |                  |                  |                  |                  |
|------------------|------------------|------------------|------------------|------------------|------------------|
| 0-10°C           | -35+35°C         | -10+40°C         | 4-40°C           | 0-60°C           | 0-90°C           |
|                  |                  |                  |                  |                  |                  |
| 66MZ0000010502FW | 66MZ006-350352FW | 66MZ006-100402FW | 66MZ0060040402FW | 66MZ0060000602FW | 66MZ0060000902FW |
| 30-90°C          | 30-110°C         | 50-200°C         | 50-300°C         | 100-400°C        | 100-500°C        |
|                  |                  |                  |                  |                  |                  |
| 66MZ0060300901FW | 66MZ0060301101FW | 66MZ0060502001FW | 66MZ0060503001FW | 66MZ0061004007FW | 66MZ0061005007FW |

°F Printing

|                  |                  |                  |                  |                  |                  |
|------------------|------------------|------------------|------------------|------------------|------------------|
| 32-50°F          | -30+95°F         | 15-105°F         | 40-105°F         | 32-140°F         | 32-195°F         |
|                  |                  |                  |                  |                  |                  |
| 66MZ0000010502FW | 66MZ006-350352FX | 66MZ006-100402FX | 66MZ0060040402FX | 66MZ0060000602FX | 66MZ0060000902FX |



# Control Thermostats

| 85-195°F   | 85-230°F   | 120-390°F  | 120-570°F  | 210-750°F        | 210-930°F        |
|--|--|--|--|------------------|------------------|
|  |  |  |  |                  |                  |
| 66MZ0060300901FX   | 66MZ0060301101FX                                 | 66MZ0060502001FX                                 | 66MZ0060503001FX                                       | 66MZ0061004007FX | 66MZ0061005007FX |
| <b>Modern design soft grip knob, dia.41mm. Polycarbonate and rubber.</b> | <b>Skirt knob, dia 50mm, black ABS.</b>          | <b>US 2" size knob, dia 50mm. Black PA66.</b>    | <b>Miniature knob dia. 10mm. Black PA66.</b>           |                  |                  |
|  |  |  |  |                  |                  |
|  |  |  |  |                  |                  |
| 66MZ*  | 66MU*  | 66MP*  | 66MQ   |                  |                  |
| <b>Black or chromed ABS bezel, for dia. 41mm knobs.</b>                  | <b>Black ABS bezel for knobs dia. 50 to 51mm</b> | <b>Stainless steel bezel for knobs dia. 41mm</b> | <b>Stainless steel bezel for knobs dia. 50 to 51mm</b> |                  |                  |
|  |  |  |  |                  |                  |
|  |  |  |  |                  |                  |
| Black: 66EN1<br>Chromed: 66EN3   | Black: 66EN4**<br>Chromed: 66EN6                 | 66EN2**  | 66EN5  |                  |                  |

\* Full knob reference with printing has 16 characters. Many others knobs are available, see the full knob list at the end of catalogue N°1.  
 \*\* Low cost versions also available in Nickel or Chrome plated steel.

Because of permanent improvement of our products, drawings, descriptions, features used on these data sheets are for guidance only and can be modified without prior advice





# Control Thermostats

## Bulb and capillary thermostat, temperature range 100-500°C Type 8GB100500

### Dimensions

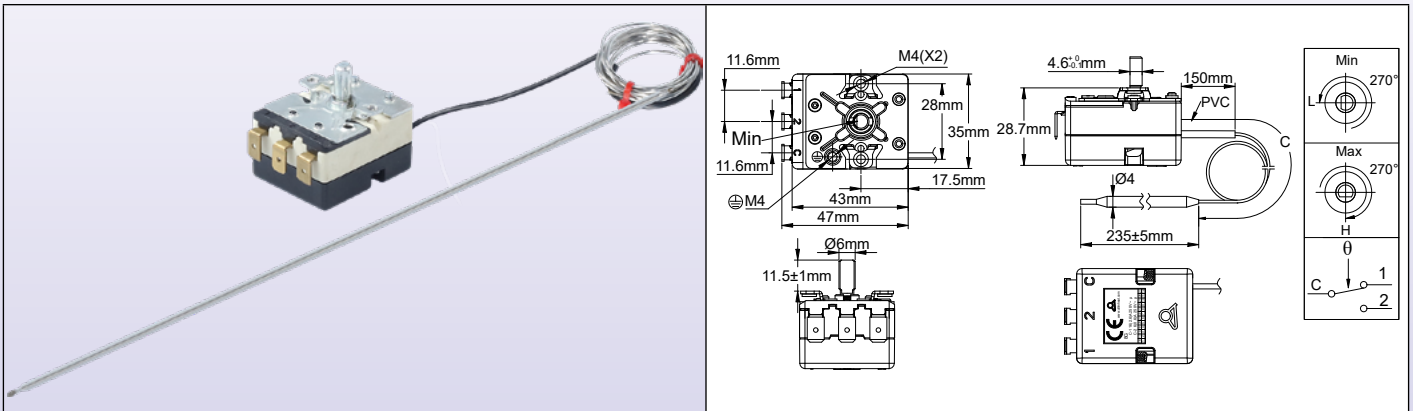

### Applications

Thermostats for furnaces and ovens which the operating temperature is higher than 320°C, such as pizza ovens. Their temperature resistance is outstanding.

### Main features

**Housing dimensions:** 43 × 35 × 29mm (without terminals).

**Bulb and capillary:** stainless steel. Capillary minimum bending radius 5mm.

**Temperature sensing element:** liquid metalloid filled.

**Terminals:** 6.3 × 0.8 quick connect terminals. M4 screws also available on request.

**Adjustment:** dia. 6mm shaft with 4.6mm flat, length 11.5mm. Other lengths, screw driver adjustment or fixed setting available on request.

**Mounting:** front bracket with 2 × M4 threads, 28mm distance.

**Contact:** SPDT

**Electrical rating:**

- Open on temperature rise contact (C-1) 16A(2.6) 250VAC

- Close on temperature rise contact (C-2) 6A(0.6) 250VAC

**Electrical life:** >100,000 cycles.

### Main references

| Reference        | Temperature range     | Capillary length (C, mm) | Bulb diameter (mm) | Bulb length (mm) | Differential       | Max temperature on bulb |
|------------------|-----------------------|--------------------------|--------------------|------------------|--------------------|-------------------------|
| 8GB100500AE40000 | 100-500°C (210-930°F) | 500                      | 4                  | 235±5            | 10°C±2°C (18±3.6F) | 550°C (1000°F)          |
| 8GB100500AG40000 | 100-500°C (210-930°F) | 750                      | 4                  | 235±5            | 10°C±2°C (18±3.6F) | 550°C (1000°F)          |
| 8GB100500AN40000 | 100-500°C (210-930°F) | 1400                     | 4                  | 235±5            | 10°C±2°C (18±3.6F) | 550°C (1000°F)          |

Other temperature ranges available on request.

### Printed knobs and accessories

| Knob printings   |                  | Knob sizes      | Bezels    |                   |                 |
|------------------|------------------|-----------------|-----------|-------------------|-----------------|
| 100-500°C        | 212-930°F        | PC + Santoprene | Black ABS | Chrome plated ABS | Stainless steel |
|                  |                  |                 |           |                   |                 |
| 66MZ0061005009LW | 66MZ0061005009LX | 66MZ006*****    | 66EN1     | 66EN3             | 66EN2           |



# Control Thermostats

Single pole control thermostat, bulb and capillary, front board mounting with 2 screws M4, 28mm distance

Type KQA and KTA

Dimensions

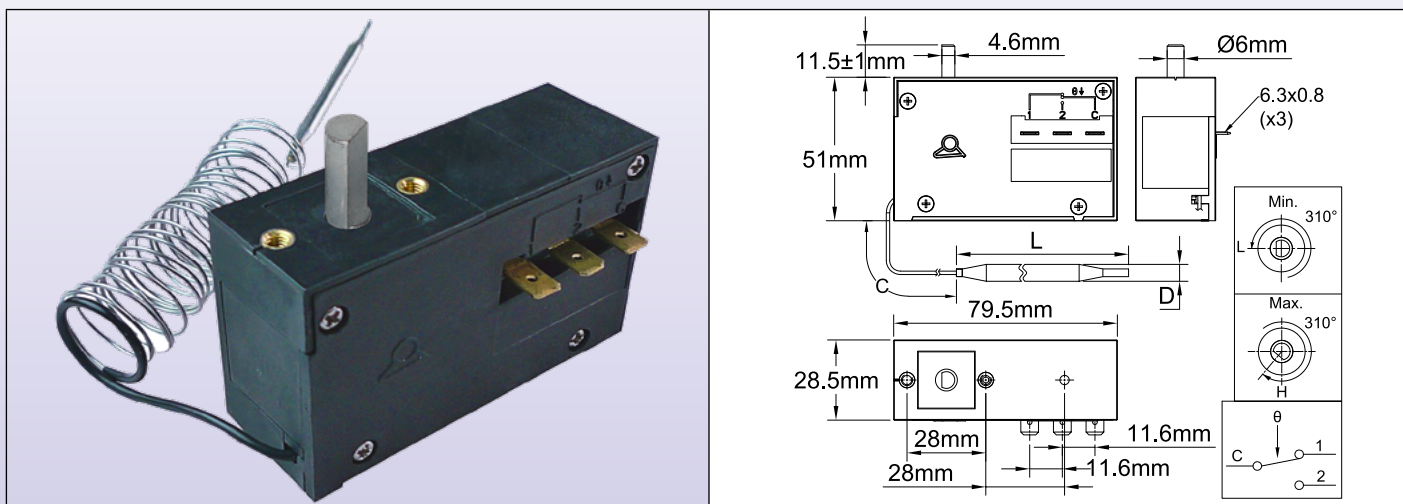

## Applications

**Housing dimensions:** 79.5 × 51 × 28.5mm

**Bulb and capillary:** copper or stainless steel depending of temperature range, standard capillary length 1500mm. Capillary minimum bending radius 5mm.

**Temperature sensing element:** liquid filled bulb and capillary.

**Terminals:** 3 quick connect terminals 6.3 × 0.8mm.

**Adjustment:** dia. 6mm shaft with 4.6mm flat, length 11.5mm.

**Mounting:** front board, with 2 screws M4, 28mm distance.

**Rating:** 16A (¼ HP) 250VAC, 16A 400V res.

**Contacts:** SPDT (snap action contact.)

**Electrical life:** >100,000 cycles at nominal rating.

## Main references

| References with standard differential* | Temperature range** (°C/ °F) | Capillary length (C, mm) | Bulb diameter (D, mm) | Bulb length (L, mm) | Differential (°C/ °F) | Max temperature on bulb(°C/ °F) |
|--|------------------------------|--------------------------|-----------------------|---------------------|-----------------------|---------------------------------|
| KQA-250252200                          | -25+25°C (-15+80°F)          | 1500                     | 6.4                   | 152                 | 3±2°C (5.5±3.6°F)     | 50°C (120°F)                    |
| KQA-100152200                          | -10+15°C (15-60°F)           | 1500                     | 6.4                   | 152                 | 3±2°C (5.5±3.6°F)     | 50°C (120°F)                    |
| KQA0000502000                          | 0-50°C (32-120°F)            | 1500                     | 6.4                   | 152                 | 3±2°C (5.5±3.6°F)     | 60°C (140°F)                    |
| KQA0000705200                          | 0-70°C (32-160°F)            | 1500                     | 4.8                   | 130                 | 5±3°C (9±5.4°F)       | 160°C (320°F)                   |
| KQA0000701200                          | 0-70°C (32-160°F)            | 3000                     | 4.8                   | 130                 | 5±3°C (9±5.4°F)       | 160°C (320°F)                   |
| KQA0200905000                          | 20-90°C (70-195°F)           | 1500                     | 4.8                   | 130                 | 5±3°C (9±5.4°F)       | 160°C (320°F)                   |
| KQA0200901000                          | 20-90°C (70-195°F)           | 3000                     | 4.8                   | 130                 | 5±3°C (9±5.4°F)       | 160°C (320°F)                   |
| KQA0101505000                          | 10-150°C (50-300°F)          | 1500                     | 4.8                   | 130                 | 5±3°C (9±5.4°F)       | 160°C (320°F)                   |
| KQA0101501000                          | 10-150°C (50-300°F)          | 3000                     | 4.8                   | 130                 | 5±3°C (9±5.4°F)       | 160°C (320°F)                   |
| KQA0802000000                          | 80-200°C (175-390°F)         | 1500                     | 4                     | 100                 | 10±4°C (18±7°F)       | 320°C (610°F)                   |
| KQA0503000000                          | 50-300°C (120-570°F)         | 1500                     | 4                     | 100                 | 10±4°C (18±7°F)       | 320°C (610°F)                   |
| KQA0104507200                          | 10-450°C (50-840°F)          | 1500                     | 4.8                   | 120                 | 20±6°C (36±11°F)      | 760°C (1400°F)                  |
| KQA0104509200                          | 10-450°C (50-840°F)          | 3000                     | 4.8                   | 120                 | 20±6°C (36±11°F)      | 760°C (1400°F)                  |
| KQA0605007000                          | 60-500°C (140-930°F)         | 1500                     | 4.8                   | 120                 | 20±6°C (36±11°F)      | 760°C (1400°F)                  |
| KQA0605009000                          | 60-500°C (140-930°F)         | 3000                     | 4.8                   | 120                 | 20±6°C (36±11°F)      | 760°C (1400°F)                  |
| KQA1806007000                          | 180-600°C (360-1110°F)       | 1500                     | 4.8                   | 120                 | 20±6°C (36±11°F)      | 760°C (1400°F)                  |
| KQA1806009000                          | 180-600°C (360-1110°F)       | 3000                     | 4.8                   | 120                 | 20±6°C (36±11°F)      | 760°C (1400°F)                  |
| KQA2807007000                          | 280-700°C (540-1290°F)       | 1500                     | 3                     | 300                 | 20±6°C (36±11°F)      | 760°C (1400°F)                  |

Caution: bulbs and capillaries of ranges above 400°C are filled with sodium potassium eutectic. If they leak or are broken, this liquid will ignite if in contact with water.

\* For types with differential reduced of about 30%, replace KQA by KTA in the part number (These types cannot be used on voltages over 250VAC).

\*\* Many other temperature ranges are available on request.



# Control Thermostats

## Single pole control thermostat, bulb and capillary, DIN rail mounting Type KO-V

### Dimensions

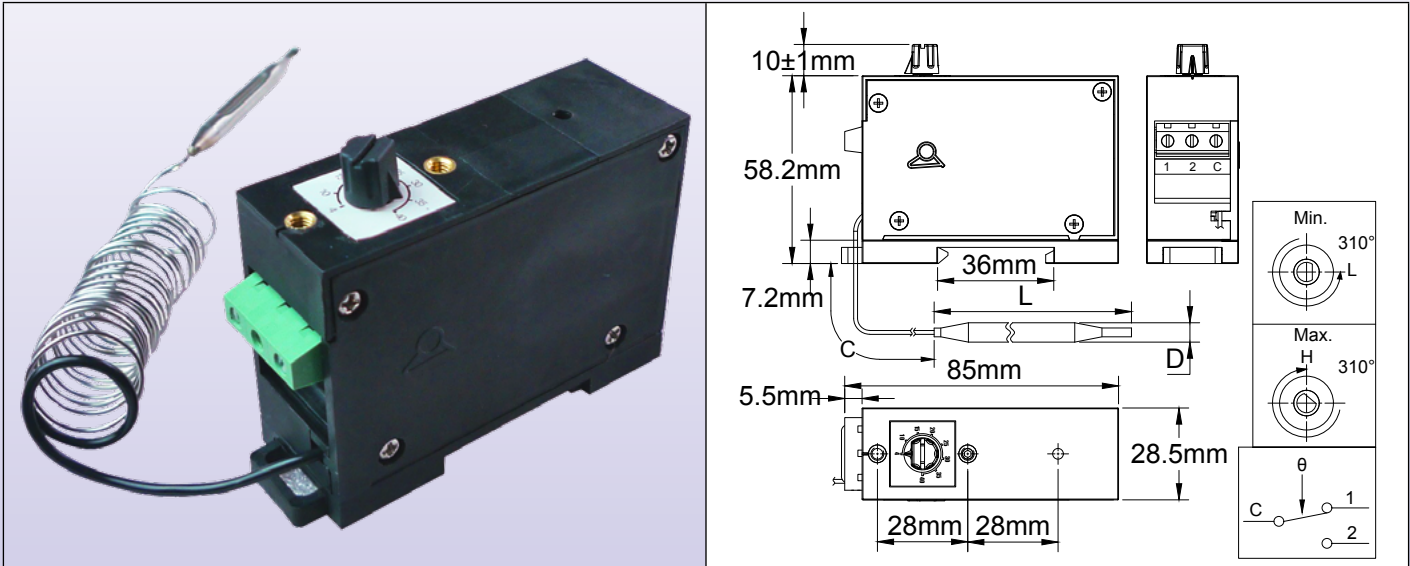

### Applications

**Housing dimensions:** 85 × 58.2 × 28.5mm (Knob not included).

**Bulb and capillary:** copper or stainless steel depending of temperature range, standard capillary length 1500mm. Capillary minimum bending radius 5mm.

**Temperature sensing element:** liquid filled bulb and capillary.

**Terminals:** 3 way screw terminal.

**Adjustment:** dia. 6mm shaft with 4.6mm flat, length 10mm, equipped with miniature knob and printed dial.

**Mounting:** on 35mm DIN rail, upon EN500022.

**Rating:** 16A (¼ HP) 250VAC, 16A 400V res.

**Contacts:** SPDT (snap action contact).

**Electrical life:** >100,000 cycles at nominal rating.

### Main references

| References with standard differential | Temperature range (°C/ °F) | Capillary length (C, mm) | Bulb diameter (D, mm) | Bulb length (L, mm) | Differential (°C/ °F) | Max temperature on bulb |
|---------------------------------------|----------------------------|--------------------------|-----------------------|---------------------|-----------------------|-------------------------|
| KOA-25025220V                         | -25+25°C (-15+80°F)        | 1500                     | 6.4                   | 152                 | 3±2°C (5.5±3.6°F)     | 50°C (120°F)            |
| KOA-10015220V                         | -10+15°C (15-60°F)         | 1500                     | 6.4                   | 152                 | 3±2°C (5.5±3.6°F)     | 50°C (120°F)            |
| KOA000050200V                         | 0-50°C (32-120°F)          | 1500                     | 6.4                   | 152                 | 3±2°C (5.5±3.6°F)     | 60°C (140°F)            |
| KOA000070520V                         | 0-70°C (32-160°F)          | 1500                     | 4.8                   | 130                 | 5±3°C (9±5.4°F)       | 160°C (320°F)           |
| KOA000070120V                         | 0-70°C (32-160°F)          | 3000                     | 4.8                   | 130                 | 5±3°C (9±5.4°F)       | 160°C (320°F)           |
| KOA020090500V                         | 20-90°C (70-195°F)         | 1500                     | 4.8                   | 130                 | 5±3°C (9±5.4°F)       | 160°C (320°F)           |
| KOA020090100V                         | 20-90°C (70-195°F)         | 3000                     | 4.8                   | 130                 | 5±3°C (9±5.4°F)       | 160°C (320°F)           |
| KOA010150500V                         | 10-150°C (50-300°F)        | 1500                     | 4.8                   | 130                 | 5±3°C (9±5.4°F)       | 160°C (320°F)           |
| KOA010150100V                         | 10-150°C (50-300°F)        | 3000                     | 4.8                   | 130                 | 5±3°C (9±5.4°F)       | 160°C (320°F)           |
| KOA080200000V                         | 80-200°C (175-390°F)       | 1500                     | 4                     | 100                 | 10±4°C (18±7°F)       | 320°C (610°F)           |
| KOA050300000V                         | 50-300°C (120-570°F)       | 1500                     | 4                     | 100                 | 10±4°C (18±7°F)       | 320°C (610°F)           |
| KOA010450720V                         | 10-450°C (50-840°F)        | 1500                     | 4.8                   | 120                 | 20±6°C (36±11°F)      | 760°C (1400°F)          |
| KOA010450920V                         | 10-450°C (50-840°F)        | 3000                     | 4.8                   | 120                 | 20±6°C (36±11°F)      | 760°C (1400°F)          |
| KOA060500700V                         | 60-500°C (140-930°F)       | 1500                     | 4.8                   | 120                 | 20±6°C (36±11°F)      | 760°C (1400°F)          |
| KOA060500900V                         | 60-500°C (140-930°F)       | 3000                     | 4.8                   | 120                 | 20±6°C (36±11°F)      | 760°C (1400°F)          |
| KOA180600700V                         | 180-600°C (360-1110°F)     | 1500                     | 4.8                   | 120                 | 20±6°C (36±11°F)      | 760°C (1400°F)          |
| KOA180600900V                         | 180-600°C (360-1110°F)     | 3000                     | 4.8                   | 120                 | 20±6°C (36±11°F)      | 760°C (1400°F)          |
| KOA280700700V                         | 280-700°C (540-1290°F)     | 1500                     | 3                     | 300                 | 20±6°C (36±11°F)      | 760°C (1400°F)          |

Caution: bulbs and capillaries of ranges above 400°C are filled with sodium potassium eutectic. If they leak or are broken, this liquid will ignite if in contact with water.



# Control Thermostats

## 3 × 16A control thermostat.

### Type 8C

#### Dimensions

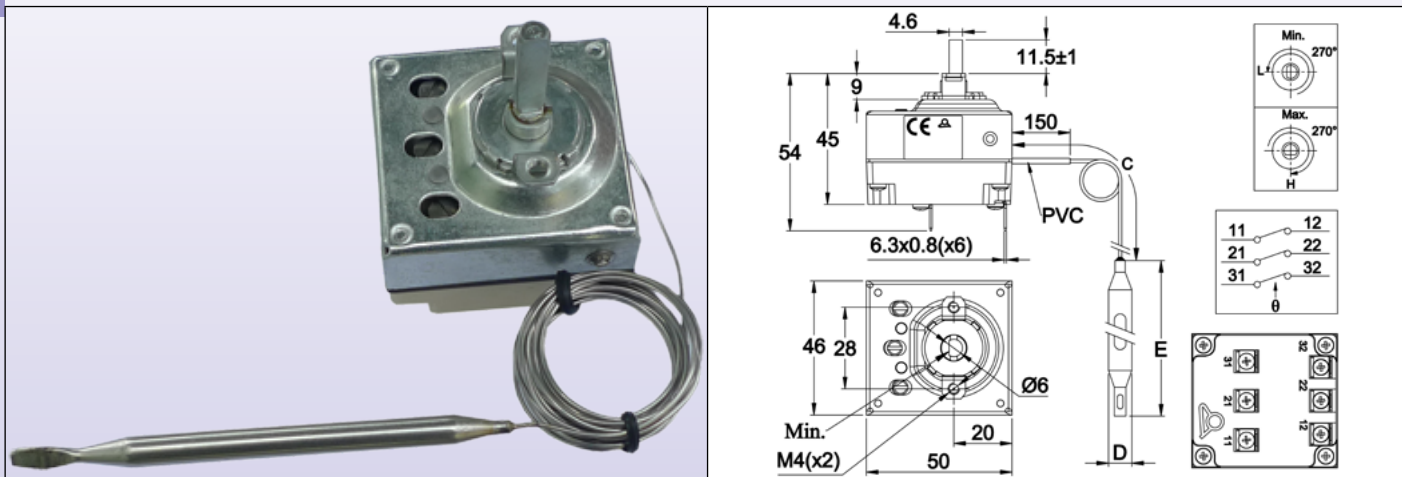

### Technical features

**Housing dimensions:** 46 × 50 × 45mm (without terminals.)

**Bulb and capillary:** stainless steel, capillary length 250mm or 1500mm, 150mm long PVC sleeve on capillary. Capillary minimum bending radius 5mm.

**Temperature sensing element:** liquid filled bulb and capillary.

**Terminals:** 6.35 × 0.8 quick connect terminals. M4 screws also available on request.

**Adjustment:** dia. 6mm shaft with 4.6mm flat, (other lengths or fixed setting available on request).

**Mounting:** front bracket with 2 × M4 threads, 28mm distance.

**Rating:** 3 × 16A(4) 250VAC, 10A 400VAC

**Contacts:** 3 × ST with snap action contact, 3PDT available on request.

### Main references

| Reference        | Temperature range (°C/°F) | Capillary length (mm) | Bulb diameter (mm) | Bulb length (mm) | Differential (°C/°F) | Max temperature on bulb (°C/°F) |
|------------------|---------------------------|-----------------------|--------------------|------------------|----------------------|---------------------------------|
| 8CB-35035AO60001 | -35+35°C (-30+95°F)       | 1500                  | 6                  | 95               | 4±2°C/ 7±3.6°F       | 50°C/ 122°F                     |
| 8CB-35035AA60001 | -35+35°C (-30+95°F)       | 250                   | 6                  | 95               | 4±2°C/ 7±3.6°F       | 50°C/ 122°F                     |
| 8CB004040AO60001 | 4-40°C (40-105°F)         | 1500                  | 6                  | 160              | 4±2°C/ 7±3.6°F       | 50°C/ 122°F                     |
| 8CB004040AA60001 | 4-40°C (40-105°F)         | 250                   | 6                  | 160              | 4±2°C/ 7±3.6°F       | 50°C/ 122°F                     |
| 8CB030090AO60001 | 30-90°C (85-195°F)        | 1500                  | 6                  | 86               | 6±3°C/ 42.8±37.4°F   | 110°C/ 230°F                    |
| 8CB030110AO60001 | 30-110°C (85-230°F)       | 1500                  | 6                  | 70               | 6±3°C/ 42.8±37.4°F   | 130°C/ 266°F                    |
| 8CB050200AO60001 | 50-200°C (120-390°F)      | 1500                  | 6                  | 57               | 13±4°C/ 55.4±39.2°F  | 220°C/ 428°F                    |
| 8CB050300AO30001 | 50-300°C (120-570°F)      | 1500                  | 3                  | 165              | 15±5°C/ 59±41°F      | 320°C/ 608°F                    |

### °C Printing

| -35+35°C         | 4-40°C           | 30-90°C          | 30-110°C         | 50-200°C         | 50-300°C         |
|------------------|------------------|------------------|------------------|------------------|------------------|
|                  |                  |                  |                  |                  |                  |
| 66MZ006-350352FW | 66MZ0060040402FW | 66MZ0060300901FW | 66MZ0060301101FW | 66MZ0060502001FW | 66MZ0060503001FW |

### °F Printing

| 30+95°F          | 40-105°F         | 85-195°F         | 85-230°F         | 120-390°F        | 120-570°F        |
|------------------|------------------|------------------|------------------|------------------|------------------|
|                  |                  |                  |                  |                  |                  |
| 66MZ006-350352FX | 66MZ0060040402FX | 66MZ0060300901FX | 66MZ0060301101FX | 66MZ0060502001FX | 66MZ0060503001FX |



# Control Thermostats

## Soft grip knob and bezel dimensions

|                   |                 |           |                   |                 |
|-------------------|-----------------|-----------|-------------------|-----------------|
| <b>Dimensions</b> |                 |           |                   |                 |
|                   |                 |           |                   |                 |
| <b>References</b> | 66MZ.....       | 66EN1     | 66EN3             | 66EN2           |
| <b>Material</b>   | PC + Santoprene | Black ABS | Chrome plated ABS | Stainless steel |

Many other knobs are available, see the full knob list at the end of this catalogue.

Because of permanent improvement of our products, drawings, descriptions, features used on these data sheets are for guidance only and can be modified without prior advice



# Control Thermostats

## 15A Single pole rod thermostat. Types SR and SU

### Dimensions

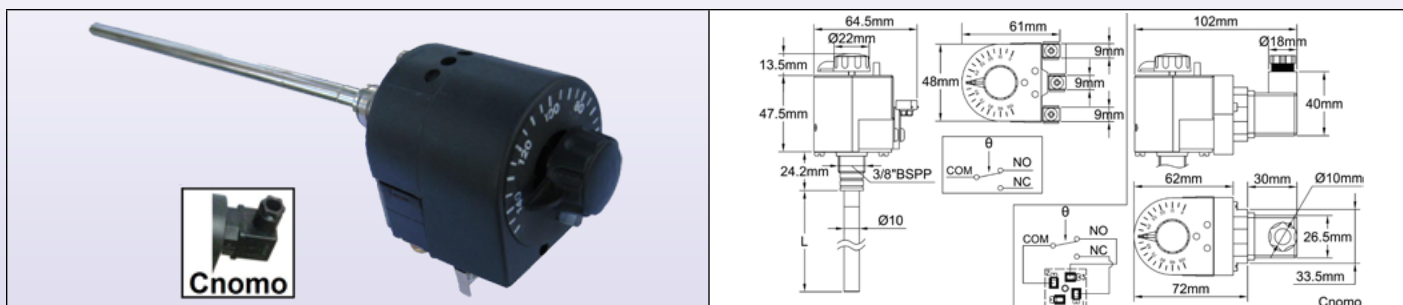

### Technical features

**Applications:** water and liquid temperature control, circulation heaters, hydraulic circuits oil temperature etc...

**Temperature ranges:** 0-50°C (32-122°F), 10-60°C (50-140°F), 30-90°C (86-194°F), 0-100°C (32-212°F), 40-140°C (104-284°F), 0-150°C (32-302°F).

**Housing dimensions:** 65 × 48 × 48mm (knob not included.)

**Material:** PA66 housing, and Aisi 304 stainless steel rod.

**Temperature sensing element:** Invar/ stainless steel bimetal rod, temperature sensing on full rod length.

**Electrical connections:** screw terminals.

#### Mounting:

• *For liquid temperature sensing:* inside pocket with internal diameter > 10mm, or directly on 3/8" BSP thread under the head, or with 3/8 × 1/2" fitting (see accessories).

• *For air temperature sensing measurement:* with stainless steel bracket.

**Rating:** 16(4)A 250/ 400VAC, 300,000 cycles. Reduced differential model is not recommended for 400V applications.

**Contacts:** SPDT, snap action.

**Max ambient temperature on the head:** 85°C (185°F)

#### Options:

• 3 fixed setting staggered contacts for hydraulic power units: ask for specific data sheet (Type S3F)

• Cnomo electrical connector

• Thermovelocimetric version (detects only fast temperature change, used in fire detection and dry run protection).

**Type:** VV, specific data sheet on request.

• Other temperature ranges.

• IP65 aluminum housing: see catalogue N°2

**Accessories:** BSPT 1/2 stainless steel pocket, fittings, brackets, see description and references at the end of this catalogue.

**Approvals:** comply with EN 60730-1 and EN 60730-2 standards.

### Main references

| Temperature range °C (°F) | Rod length (mm) | Reference with standard differential* | Differential value °C (°F) | Reference with reduced differential* | Differential value °C (°F) | Max. temperature on rod °C (°F) |
|---------------------------|-----------------|---------------------------------------|----------------------------|--------------------------------------|----------------------------|---------------------------------|
| 0-50°C (32-122°F)         | 450             | SRA00005000450                        | 3±1.5°C (5.4±2.7°F)        | SUA00005000450                       | 1.5±1°C (2.7±1.8°F)        | 70°C (158°F)                    |
| 10-60°C (50-140°F)        | 450             | SRA01006000450                        | 3±1.5°C (5.4±2.7°F)        | SUA01006000450                       | 1.5±1°C (2.7±1.8°F)        | 80°C (176°F)                    |
| 30-90°C (86-194°F)        | 380             | SRA03009000380                        | 4±2°C (7.2±3.6°F)          | SUA03009000380                       | 2±1°C (3.6±1.8°F)          | 110°C (230°F)                   |
| 0-100°C (32-212°F)        | 230             | SRA00010000230                        | 6±3°C (10.8±5.4°F)         | SUA00010000230                       | 3±1.5°C (5.4±2.7°F)        | 130°C (266°F)                   |
| 40-140°C (104-284°F)      | 230             | SRA04014000230                        | 6±3°C (10.8±5.4°F)         | SUA04014000230                       | 3±1.5°C (5.4±2.7°F)        | 170°C (338°F)                   |
| 0-150°C (32-302°F)        | 170             | SRA00015000170                        | 8±4°C (14.4±7.2°F)         | SUA00015000170                       | 4±2°C (7.2±3.6°F)          | 180°C (356°F)                   |

\* These products can also be supplied with Cnomo connector electrical output: replace the last number in the reference " 0 " by " 1 "

### Accessory assemblies

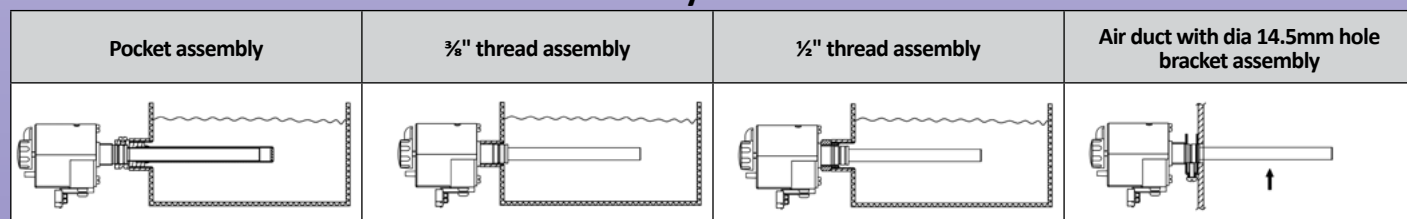

Mounting accessories are described in the last section of this catalogue.



# Control Thermostats

## 15A Single pole rod thermostat with dead zone. Types VR and VU

### Dimensions

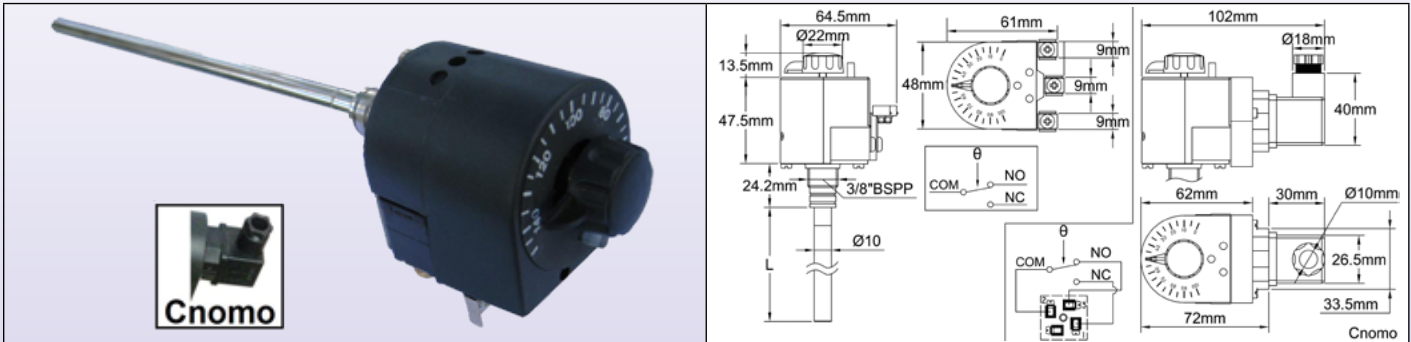

### Technical features

**Applications:** these thermostat have a rod section that is not sensible to temperature. This allows to keep the thermostat head away from high temperatures. Therefore, they are more used in air duct temperature control.

**Temperature ranges:** 0-100°C (32-212°F), 0-200°C (32-392°F), 0-300°C (32-572°F), 0-400°C (32-752°F)

**Housing dimensions:** 65 × 48 × 48mm (knob not included.)

**Material:** PA66 housing, and Aisi 304 stainless steel rod.

**Temperature sensing element:** Invar/ stainless steel bimetal rod, temperature sensing.

**Electrical connections:** screw terminals

#### Mounting:

- For liquid temperature sensing: inside pocket with internal diameter > 10mm, or directly on 3/8" BSPP thread under the head, or with 3/8 × 1/2" fitting (see accessories).

- For air temperature sensing measurement: with stainless steel bracket, with or without rod cooler.

**Rating:** 16(4)A 250/ 400VAC, 300,000 cycles. Reduced differential model is not recommended for 400V applications.

**Contacts:** SPDT, snap action.

**Max ambient temperature on the head:** 85°C (185°F)

#### Options:

- Cnomo electrical connector.

- Other temperature ranges.

- Other rod lengths.

- IP65 aluminum housing: see catalogue N°2

**Accessories:** BSPT 1/2" stainless steel pocket, fittings, bracket, see full description and references at end of this catalogue

**Approvals:** comply with EN 60730-1 and EN 60730-2 standards.

### Main references

| Temperature range °C (°F) | Rod length (mm) | Reference with standard differential* | Differential value °C (°F) | Reference with reduced differential* | Differential value °C (°F) | Max. temperature on rod °C (°F) |
|---------------------------|-----------------|---------------------------------------|----------------------------|--------------------------------------|----------------------------|---------------------------------|
| 0-100°C (32-212°F)        | 300             | VRA00010000300                        | 6±3°C (10.8±5.4°F)         | VUA00010000300                       | 3±1.5°C (5.4±2.7°F)        | 130°C (266°F)                   |
| 0-100°C (32-212°F)        | 450             | VRA00010000450                        | 6±3°C (10.8±5.4°F)         | VUA00010000450                       | 3±1.5°C (5.4±2.7°F)        | 130°C (266°F)                   |
| 0-200°C (32-392°F)        | 300             | VRA00020000300                        | 12±6°C (21.6±10.8°F)       | VUA00020000300                       | 6±3°C (10.8±5.4°F)         | 230°C (446°F)                   |
| 0-300°C (32-572°F)        | 300             | VRA00030000300                        | 18±9°C (32.4±16.2°F)       | VUA00030000300                       | 9±4.5°C (16.2±8.1°F)       | 350°C (662°F)                   |
| 0-400°C (32-752°F)        | 450             | VRA00040000450                        | 24±12°C (43.2±21.6°F)      | VUA00040000450                       | 12±6°C (21.6±10.8°F)       | 450°C (842°F)                   |
| 0-150°C (32-302°F)        | 170             | SRA00015000170                        | 8±4°C (14.4±7.2°F)         | SUA00015000170                       | 4±2°C (7.2±3.6°F)          | 180°C (356°F)                   |

\* These products can also be supplied with Cnomo connector electrical output: replace the last number in the reference "0" by "1"

### Accessory assemblies

| Pocket assembly                                       | 3/8" thread assembly  | 1/2" thread assembly                                  |
|---|---|---|
|   |   |   |
| <b>Air duct with dia 14.5mm hole bracket assembly</b> | <b>Air duct with dia. 14.5 hole bracket and cooler assembly</b> | <b>Air duct with 1/2" bracket and cooler assembly</b> |
|   |   |   |

Mounting accessories are described in the last section of this catalogue.



# Control Thermostats

## Wood and solid fuel stove damper bulb and capillary thermostat.

### Type WQD

#### Dimensions

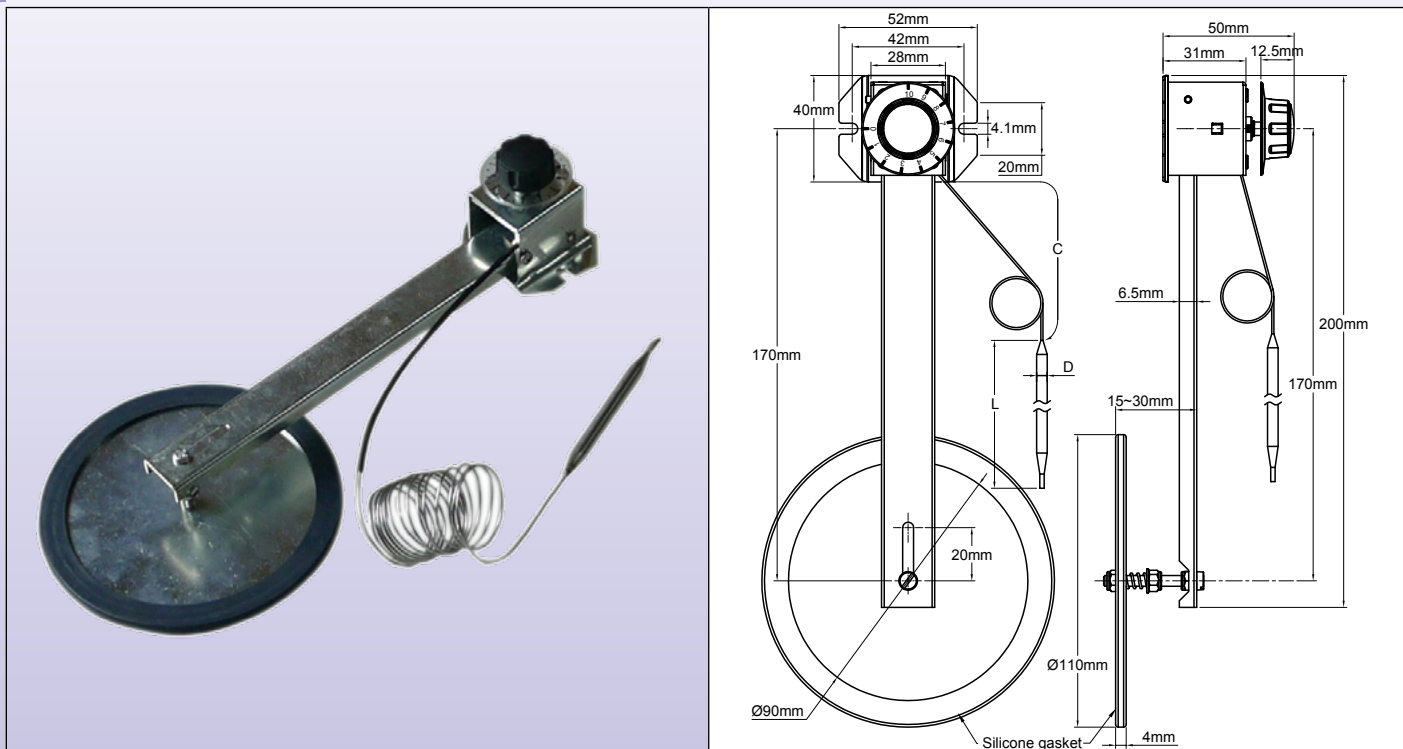

#### Applications

This thermostat is an automatic control of wood, pellets, coal or anthracite fired solid fuel appliances like room heaters, boilers, stoves, central heating units. Its modulating action provides economy in fuel consumption.

#### Main features

**Operation principle:** It controls the combustion by throttling the primary air intake to the fire. A flat damper plate at the end of the control arm is moved relative to the air intake port of the appliance in response to variations of temperature at the bulb.

It is actuated by the expansion of liquid in the bulb, through capillary tubing to a diaphragm located in the body.

**Body:** zinc plated steel.

**Shaft:** dia. 6mm, with 4.8mm flat, with 270° angular rotation.

**Fixing:** by means of the backside bracket, for dia 4mm screws, distance 42 to 48mm (Front mounting by 2 screws M4, 28mm distance available on request).

#### Temperature Ranges:

- Room Air Control 4/ 40°C (40/ 105°F). Damper displacement between 4 and 40°C (40/ 105°F), with a 170mm length arm: 12.5mm.

- Hot water 30/ 90°C (85/ 195°F). Damper displacement between 30 and 90°C (85/ 195°F), with a 170mm length arm: 9.5mm.

- Flue temperature 50/ 300°C (120/ 570°F). Damper displacement between 50 and 300°C (120/ 570°F), with a 170mm length arm: 9.5mm.

Other temperature ranges and displacement available on request (MOQ apply).

#### Damper plates:

Damper plates are available in circular form in dia. 80mm and dia. 120mm. (Rectangular forms on request). They are spring mounted to permit self-alignment of the plate in the closed position.

Damper plate position can be adjusted from 150 to 170mm on the arm.

Damper plates are fitted with a temperature resistant silicone gasket. Special arm length and damper plates may be made on request to suit application (MOQ apply).

#### Sensor dimensions:

Bulb and capillary are made of stainless steel.

Bulb standard dia. 3, 6 or 8mm. (Depends of temperature ranges).

Standard capillary length 300mm or 1500mm.

Because of permanent improvement of our products, drawings, descriptions, features used on these data sheets are for guidance only and can be modified without prior advice





# Control Thermostats

## Main references with 170mm arm

| Damper disc diameter | Capillary length | Temperature ranges (°C) |                         |                          |                           |
|----------------------|------------------|-------------------------|-------------------------|--------------------------|---------------------------|
|                      |                  | 4-40<br>(bulb dia. 6mm) | 4-40<br>(bulb dia. 8mm) | 30-90<br>(bulb dia. 6mm) | 50-300<br>(bulb dia. 3mm) |
| 80mm                 | 300mm            | WQD0440AC60080G0        | WQD0440AC80080G0        | WQD3090AC60080G0         | WQD50C0AC30080G0          |
| 80mm                 | 1500mm           | WQD0440AO60080G0        | WQD0440AO80080G0        | WQD3090AO60080G0         | WQD50C0AO30080G0          |
| 120mm                | 300mm            | WQD0440AC600C0G0        | WQD0440AC800C0G0        | WQD3090AC600C0G0         | WQD50C0AC300C0G0          |
| 120mm                | 1500mm           | WQD0440AO600C0G0        | WQD0440AO800C0G0        | WQD3090AO600C0G0         | WQD50C0AO300C0G0          |

## Printed knobs

|                 |                  |                  |                  |
|-----------------|------------------|------------------|------------------|
|                 | 4-40°C           | 30-90°C          | 50-300°C         |
|                 |                  |                  |                  |
|                 | 66MM0060040402FB | 66MM0060300901FB | 66MM0060503001FB |
| 0-10°F          | 40-104°F         | 5-195°F          | 120-570°F        |
|                 |                  |                  |                  |
| 66MM006000102FB | 66MM0060040402FY | 66MM0060300901FY | 66MM0060503001FY |

Many other printed knobs available, see our catalogue #1.

Because of permanent improvement of our products, drawings, descriptions, features used on these data sheets are for guidance only and can be modified without prior advice



Because of permanent improvement of our products, drawings, descriptions, features used on these data sheets are for guidance only and can be modified without prior advice



Because of permanent improvement of our products, drawings, descriptions, features used on these data sheets are for guidance only and can be modified without prior advice

# Electronic thermostats



Because of permanent improvement of our products, drawings, descriptions, features used on these data sheets are for guidance only and can be modified without prior advice



# Electronic thermostats

## Blind electronic thermostat, 16A.

**Type: 2PE2N6**

### Dimensions

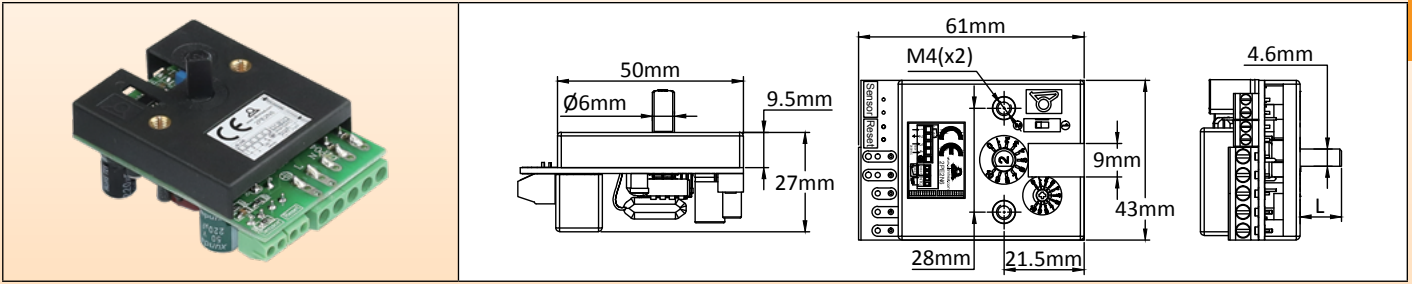

### Applications principles

This electronic thermostat for incorporation has been designed to allow a distant temperature control of flexible silicone heaters. It is mounted with two screws M4 at the same distance 28mm than bulb and capillary thermostats, uses a 6mm dia. shaft with 4.6mm flat, and its knob rotation angle is 230°. Its electrical rating is 16A 230V, identical to the electromechanical thermostats. **This is an economical solution, useful in catering equipment.**

### Main features

**Action:** On-Off.

**Size:** 60 × 43 × 23mm.

**Temperature sensor:** NTC thermistor, 10Kohms @25°C, B(25-50)= 3380

**Temperature ranges:** 20-125°C (68-260°F)

**Temperature differential:** adjustable, by potentiometer with front access, from 0.5 to 5.5°C (0.9 to 10°F) for other temperature ranges.

**Accuracy:** +/- 1% of scale (NTC sensor tolerances not included).

**Power supply:** 180 to 240V, 50Hz or 60Hz.

**Relay output:** 16A250V resistive, 100000 cycles.

**Relay action:** open on temperature rise

**Ambient:** -20+50°C, 10-85% RH.

**Power:** <2W

**Electrical connections:**

- Power supply and power relay: 2.5mm<sup>2</sup> screw terminal block.

- Temperature sensor: 1.5mm<sup>2</sup> screw terminal block.

**Adjustment shaft:** the thermostat is shipped with a dia. 6mm with 4.6mm flat shaft, length 11mm, assembled. Included is also a set of: one 15mm shaft, one 28mm shaft and one screw driver adjustment shaft.

**Options:** available with many other temperature ranges. Also available with manual reset action (Ask for full technical data sheet).

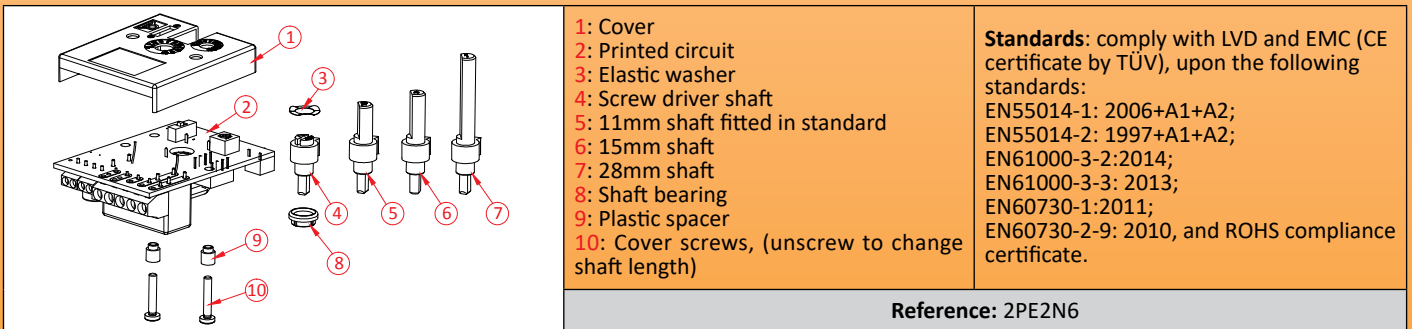

### Soft grip printed knobs references

(Must be ordered separately, not included in the electronic thermostat)

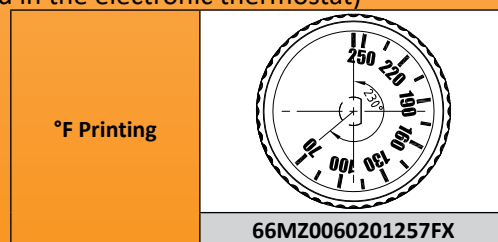
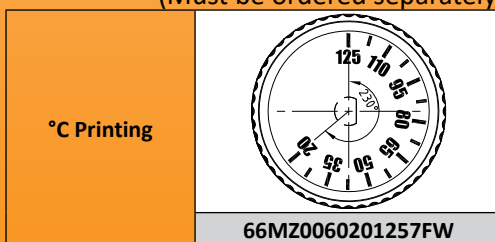



# Electronic thermostats

## Electronic thermostat, knob adjustment, remote sensor, Pt100 temperature sensor. **Type 2PE2P6**

### Dimensions

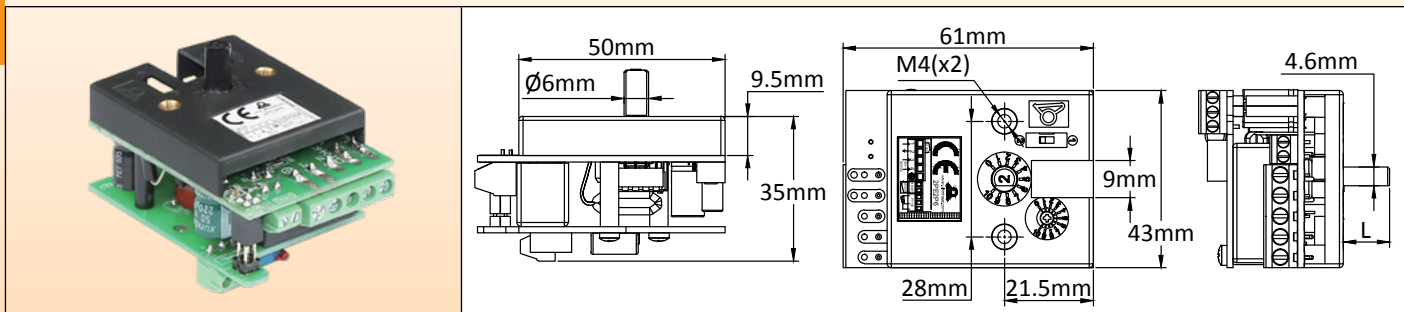

### Applications principles

This electronic thermostat for incorporation has been designed to allow a distant temperature control of flexible silicone heaters. It is mounted with two screws M4 at the same distance 28mm than bulb and capillary thermostats, uses a 6mm dia. shaft with 4.6mm flat, and its knob rotation angle is 230°. Its electrical rating is 16A 230V, identical to the electromechanical thermostats. **This is an economical solution, useful in catering equipment.**

### Main features

**Action:** On-Off.

**Size:** 61 × 43 × 35mm.

**Temperature sensor:** Pt100

**Temperature range:** 50-200°C (120-390°F)

**Temperature differential:** adjustable, by potentiometer with front access, from 0.5 to 5.5°C (0.9 to 10°F) for other temperature ranges.

**Accuracy:** +/- -1% of scale (NTC sensor tolerances not included).

**Power supply:** 180 to 240V, 50Hz or 60Hz.

**Relay output:** 16A250V resistive, 100000 cycles.

**Relay action:** open on temperature rise.

**Ambient:** -20+50°C, 10-85% RH.

**Power:** <2W

**Electrical connections:**

- Power supply and power relay: 2.5mm<sup>2</sup> screw terminal block.
- Temperature sensor: 1.5mm<sup>2</sup> screw terminal block.

**Adjustment shaft:** the thermostat is shipped with a dia. 6mm with 4.6mm flat shaft, length 11mm, assembled. Included is also a set of: one 15mm shaft, one 28mm shaft and one screw driver adjustment shaft.

**Options:** available with many other temperature ranges. Also available with manual reset action (Ask for full technical data sheet).

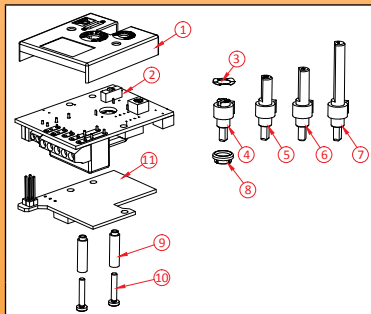

- 1: Cover
- 2: Main printed circuit board
- 3: Elastic washer
- 4: Screw driver shaft
- 5: 11mm shaft fitted in standard
- 6: 15mm shaft
- 7: 28mm shaft
- 8: Shaft bearing
- 9: Plastic spacer
- 10: Cover screws, (unscrew to change shaft length)
- 11: Pt100 input printed circuit board

**Standards:** Comply with LVD and EMC (CE certificate by TÜV), upon the following standards:  
EN55014-1:2006+A1+A2;  
EN55014-2: 1997+A1+A2;  
EN61000-3-2:2014;  
EN61000-3-3:2013;  
EN60730-1:2011;  
EN60730-2-9:2010, and ROHS compliance certificate.

**Part number:** 2PE2P6

### Soft grip printed knobs and bezels part numbers

(Must be ordered separately, not included in the electronic thermostat)

| °C Printing      | °F Printing      | Black ABS bezel | Chrome plated ABS Bezel |
|------------------|------------------|-----------------|-------------------------|
|                  |                  |                 |                         |
| 66MZ0060502001FW | 66MZ0060502001FX | 66EN1           | 66EN3                   |



# Electronic thermostats

## Digital display electronic thermostat, 16A. Type 2DNAP6

### Dimensions

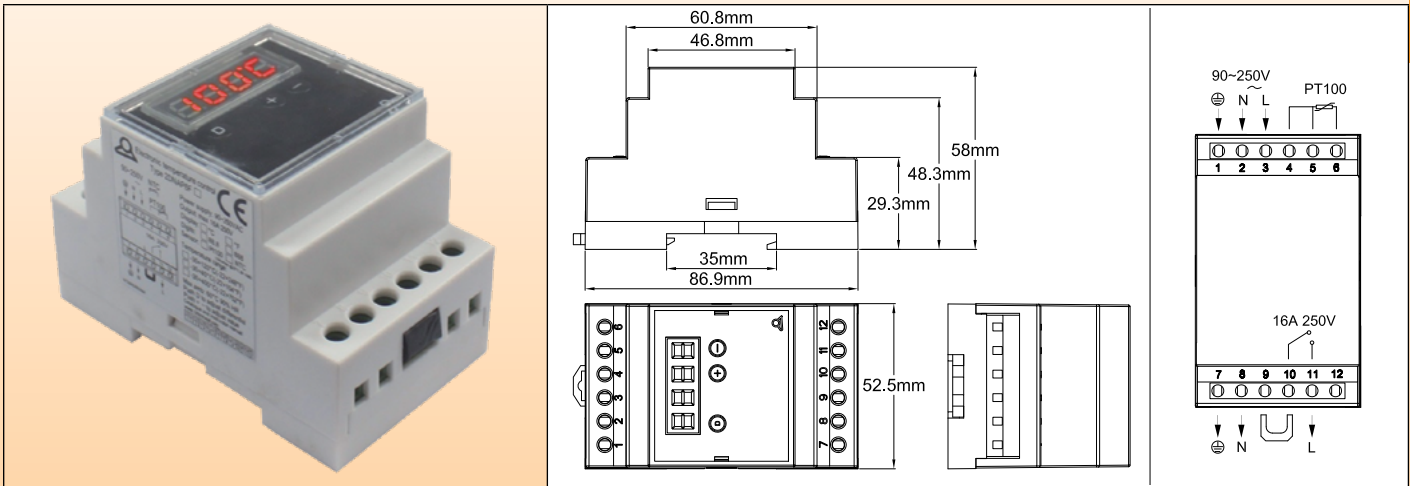

### Applications

This electronic temperature controller with **the simplest and the most instinctive setting by end user** was designed for easy incorporation inside cabinets with DIN rail mounting. It can be used by untrained operators. It provides simple On Off action temperature control.

**End user has access to set point and differential setting only.**

Adjustment of maximum temperature can be set.

### Main features

**Dimensions:** 86.9 × 58 × 52.5mm

**Display:** 3+1 digit LED. The fourth digit is used to display °C or °F.

**Set point setting:** in normal use, the display shows the measured temperature. Push “+” or “-” keys will display the set point value, and at that time it can be adjusted with “+” and “-” keys. No action during 5 seconds will register the new set point value and bring back display to measured value.

**Temperature differential setting:** in normal use, the display shows the measured temperature. Push “D” key will display the differential value, at that time it can be adjusted with “+” and “-” keys. Push “D” again or no action during 5 seconds will register the new differential value and bring back display to the measured value.

**Action:** On-Off

**Temperature sensor:** Pt100 (2 or 3 wires) or NTC 10Kohms @25°C, B= 3380 (2 wires).

**Accuracy:** +/- 1% of scale

**Temperature adjustment ranges:**

-30+120°C (-20+250°F), with 1° display

-30+200°C (-20+390°F), with 1° display

**Power supply:** 90 to 240V, 50Hz or 60Hz

**Relay output:** 16A 250V res., 100,000 cycles. Output Led displays relay position.

**Maximum possible set point adjustment by user:** push “D” button more than 10 seconds, display shows the maximum temperature that can be set by the user. Then it is possible to adjust this value with “+” and “-”. Push again on “D” or do nothing during 5 seconds will register the maximum possible setting value and control will come back to the measured valued.

**Ambient:** -20+60°C, 10-90% RH

**Power:** <4W

**Fail safe safety:**

- If no power supply, relay output contact will open.

- If Pt100 sensor or NTC is broken or not connected properly, relay output contact will open and display will show “EEE”.

- If measured temperature is higher than allowed by the set range, display will show HHH.

- If measured temperature is lower than -30.0°C or -20.0°F, display will show LLL.

**Electrical connections:**

- Power input: neutral, phase, ground, with 2.5mm<sup>2</sup> terminals.

- Power output: neutral, phase, ground, with 2.5mm<sup>2</sup> terminals for direct connection to the load.

- Temperature sensor: three 2.5mm<sup>2</sup> screw terminal.

# Electronic thermostats



One removable jumper provides a potential free relay output for applications needing a separate circuit for relay, external timer or other.

**Standards:** comply with LVD, EMC (CE certificate by TUV), ROHS and Reach.

## Main references

| References | Temperature range | Sensor | Display |
|------------|-------------------|--------|---------|
| 2DNAP6FA   | -30+120°C         | NTC    | °C      |
| 2DNAP6FB   | -20+250°F         | NTC    | °F      |
| 2DNAP6FI   | -30+200°C*        | Pt100  | °C      |
| 2DNAP6FJ   | -20+390°F*        | Pt100  | °F      |

\* It is possible to unlock this value up to 400°C (750°F).

Because of permanent improvement of our products, drawings, descriptions, features used on these data sheets are for guidance only and can be modified without prior advice





# Electronic thermostats

## Accessories for 2PE2N6 and 2PE2P6

(Must be ordered separately, not included in the electronic thermostat)

### Manual reset switch

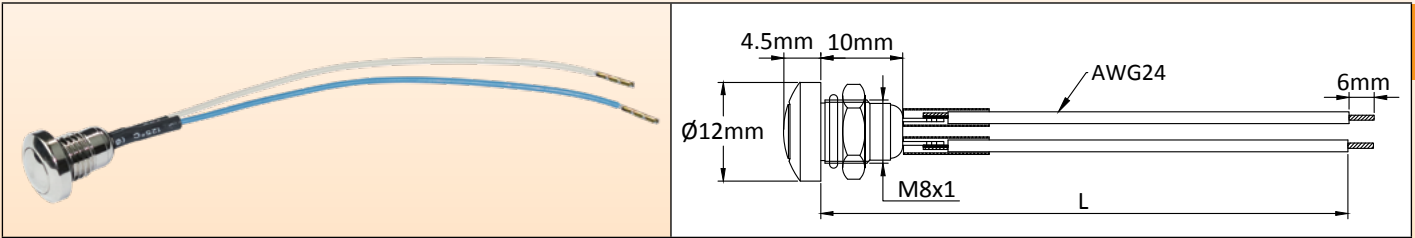

Wired switch for manual reset. Needs a 8mm dia. hole in the mounting board. Wires length 100mm. Other length on request.

|           |         |
|-----------|---------|
| Reference | 2PMR100 |
|-----------|---------|

### 66MZ Soft grip printed knobs

°C Printing

| -35+35°C         | 0-10°C           | 4-40°C           | 30-90°C          | 30-110°C         |
|------------------|------------------|------------------|------------------|------------------|
|                  |                  |                  |                  |                  |
| 66MZ006-350357FW | 66MZ0060000107FW | 66MZ0060040407FW | 66MZ0060300901FW | 66MZ0060301101FW |
| 20-125°C         | 50-200°C         | 50-300°C         | 100-400°C        | 100-500°C        |
|                  |                  |                  |                  |                  |
| 66MZ0060201257FW | 66MZ0060502001FW | 66MZ0060503001FW | 66MZ0061004007FW | 66MZ0061005007FW |

°F Printing

| -31+95°F         | 32-50°F          | 39-104°F         | 86-194°F         | 86-230°F         |
|------------------|------------------|------------------|------------------|------------------|
|                  |                  |                  |                  |                  |
| 66MZ006-350357FX | 66MZ0060000107FX | 66MZ0060040407FX | 66MZ0060300901FX | 66MZ006031101FX  |
| 68-257°F         | 122-392°F        | 122-512°F        | 210-750°F        | 210-930°F        |
|                  |                  |                  |                  |                  |
| 66MZ0060201257FX | 66MZ0060502001FX | 66MZ0060503001FX | 66MZ0061004007FX | 66MZ0061005007FX |

# Electronic thermostats



## Knobs and bezels

| Dimensions |                 |           |                   |                 |
|------------|-----------------|-----------|-------------------|-----------------|
| References | 66MZ.....       | 66EN1     | 66EN3             | 66EN2           |
| Material   | PC + Santoprene | Black ABS | Chrome plated ABS | Stainless steel |

Many other knobs are available, see last section of catalogue 1.

## Standard temperature sensors

| NTC Thermistor   | Pt100, 3 wires, 200°C   | Pt100, 3 wires, 400°C   |
|--|---|---|
|  |   |   |
|  |   |   |
| <p><b>Value:</b> 10Kohms @25°C, B= 3380<br/> <b>Accuracy:</b> +/- 1% on R25 e/+/- 1% on B<br/> <b>Temperature range:</b> -20°C+120°C<br/> <b>Probe:</b> nickel plated copper, 6 x 30mm<br/> <b>Cable:</b> AWG24, FEP + silicone insulation, dia. 3.3mm, standard length 2m. Character 10 in the reference provides sensor cable length in meters (2=2m, 3= 3m, 4=4m)</p> | <p><b>Accuracy and tolerances:</b><br/>           Class B, ±0.3°C @ 0°C. (±0.12 Ω @ 0°C).<br/> <b>Temperature range:</b> -50°C, +200°C<br/> <b>Probe:</b> stainless Steel 304, dia. 5mm x 30mm<br/> <b>Cable:</b> 3 x AWG24, FEP insulation, + metal braid + FEP, T 200°C, dia. 3mm, standard length 2m. Character 10 in the reference provides sensor cable length in meters (2=2m, 3= 3m, 4=4m)</p> | <p><b>Accuracy and tolerances:</b><br/>           Class B, ±0.3°C @ 0°C. (±0.12 Ω @ 0°C).<br/> <b>Probe temperature range:</b> -50°C, +400°C<br/> <b>Probe:</b> stainless Steel 304, dia. 4mm x 500mm.<br/> <b>Cable:</b> 3 x AWG24, FEP insulation, + metal braid + FEP, T 200°C, dia. 2.7mm, standard length 2m. Character 10 in the reference provides sensor cable length in meters (2=2m, 3= 3m, 4=4m)</p> |
| References : TNR60030C20001F6  | References : TSR50030I2000BK6   | References : TSS40500I2000BK6   |

Because of permanent improvement of our products, drawings, descriptions, features used on these data sheets are for guidance only and can be modified without prior advice



---

# Manual reset and thermal cut-outs

Because of permanent improvement of our products, drawings, descriptions, features used on these data sheets are for guidance only and can be modified without prior advice



Because of permanent improvement of our products, drawings, descriptions, features used on these data sheets are for guidance only and can be modified without prior advice



# Manual reset and thermal cut-out

## Manual reset snap action bimetal disc thermostat, 1/2" disc.

### Type 4R05

#### Dimensions

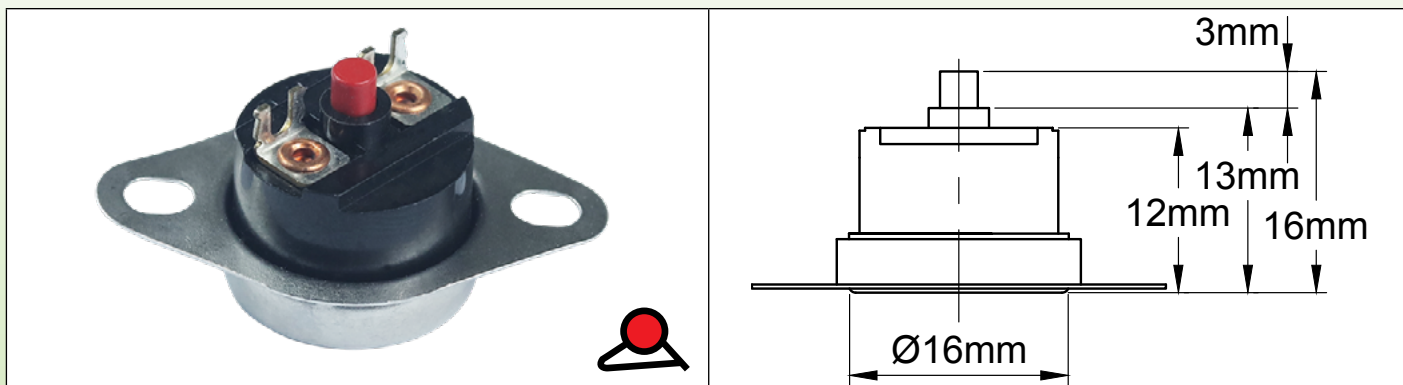

#### Technical features

**Case:** Phenolic resin (ceramic on request).

**Sensing element:** Bimetal disc.

**Calibration:** Factory fixed setting, from 30°C to 150°C (86 to 302°F). Not adjustable. Standard calibration tolerances  $\pm 4^\circ\text{C}$  to  $\pm 6^\circ\text{C}$  ( $\pm 39.2$  to  $\pm 42.8^\circ\text{F}$ ) upon models.

**Terminals:** 6.3 or 4.8 quick connect, or welding terminals.

**Differential:** Manual reset.

**Mounting:** With or without bracket.

#### Main bracket models:

- Loose bracket, two oval holes 3.2 × 3.5, for M3 screws, 24.5mm distance.
- Flat fixed bracket, two oval holes 3.2 × 3.5, for M3 screws, 24.5mm distance.
- Flat cup bracket, two oval holes 3.2 × 4.2, for M3 screws, 24mm distance.
- M4 or M5 center stud on request.

**Cap materials:** Stainless steel (SS) or aluminum (AL).

#### Ratings:

**UL:** AC120V/ 15A, AC240V/ 10A.

**CSA:** AC 125V/ 15A, AC250V/ 8A.

**VDE:** AC 250V/ 16A.

#### Main bracket types

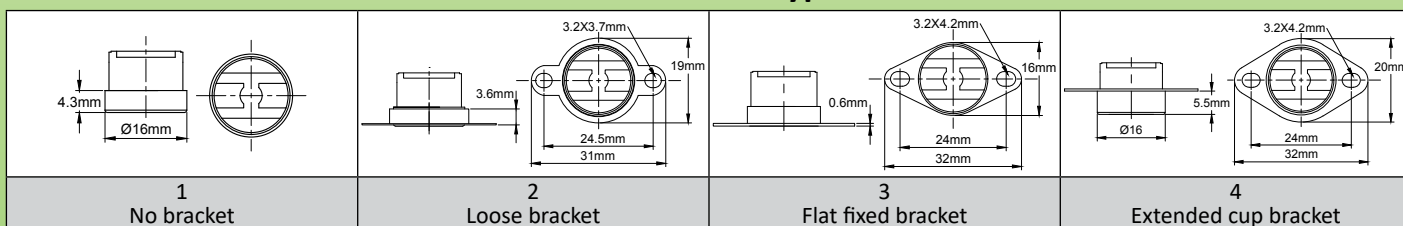

#### Main terminal types

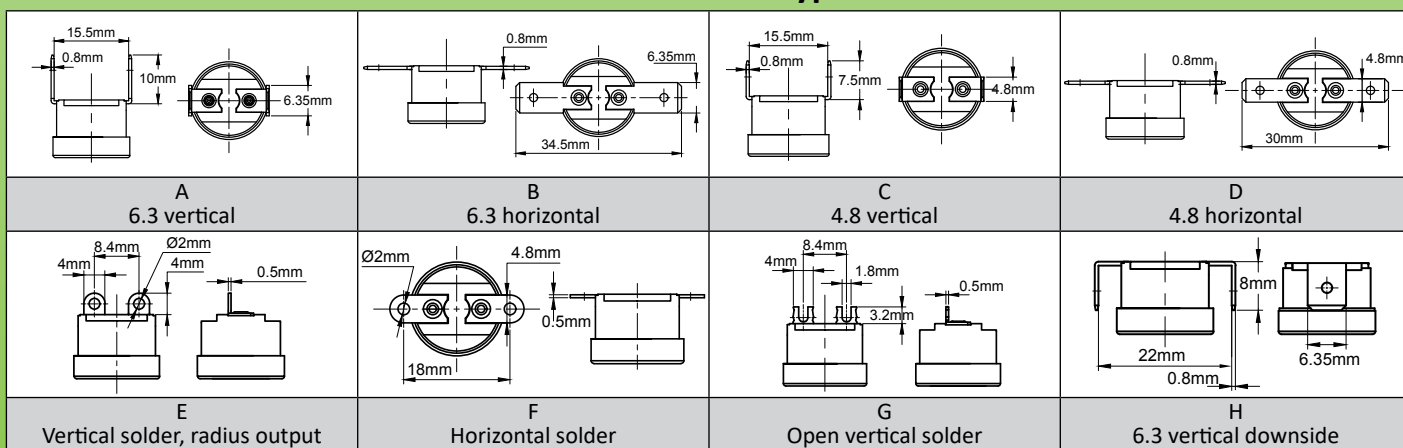

Because of permanent improvement of our products, drawings, descriptions, features used on these data sheets are for guidance only and can be modified without prior advice



# Manual reset and thermal cut-out

## Angle between terminals and bracket

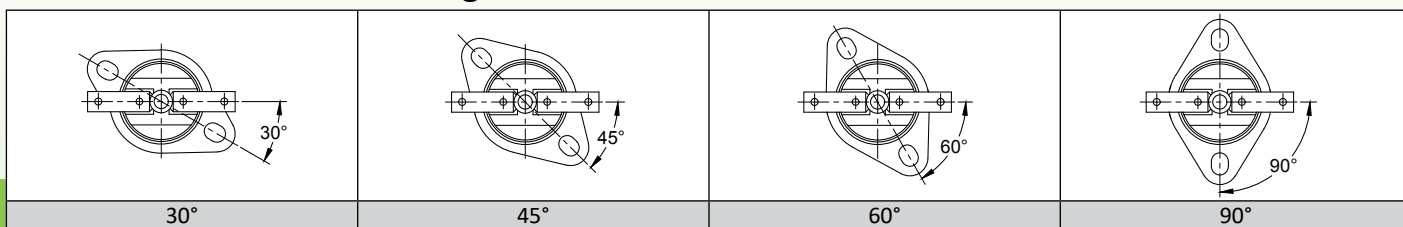

## Accessories (See more at the end of this catalogue)

|   |   |   |  |
|---|---|---|--|
|   |   |   |  |
| <p>19.5mm<br/>25mm<br/>Silicone<br/>2mm<br/>A-A<br/>4mm<br/>Ø18mm<br/>Ø7mm<br/>29mm<br/>L</p>         | <p>19.5mm<br/>25mm<br/>Silicone<br/>A-A<br/>Ø8mm<br/>Ø18mm<br/>29mm<br/>Ø10mm<br/>A<br/>A<br/>A<br/>D</p> | <p>19.5mm<br/>25mm<br/>Silicone<br/>0.8mm<br/>2mm<br/>8mm<br/>2mm<br/>A-A<br/>4mm<br/>24mm<br/>Stainless steel<br/>25mm<br/>45°<br/>Ø3.1mm (x2)<br/>Ø7mm<br/>32.5mm<br/>L<br/>D</p> | <p>15mm<br/>8mm<br/>2mm<br/>M10<br/>M10<br/>5mm<br/>13mm<br/>2.5mm<br/>Disc thermostat<br/>12.5mm<br/>Ø3mm<br/>2.5mm<br/>8mm<br/>A<br/>A</p> |
| <p>Boot without bracket (Can be used with terminals type E and G), for flat cable or 2 conductors</p> | <p>Boot without bracket (Can be used with terminals type E and G), for round cable dia. 6 to 8mm</p>      | <p>Boot with stainless steel bracket (can be used with terminals type E and G, thermostat bracket type 4 with 45° angle), for flat cable or 2 conductors</p>                        | <p>Allows to mount a manual reset disc thermostat with side actuated button. Needs a 10mm drill on the side mounting wall.</p>               |
| <p>Reference 9BBJO1000004011A</p>   | <p>Reference 9BBJO1000004019A</p>   | <p>Reference 9BBJO1000004012A (Silicone boot)<br/>9BBAE1000000017A (Bracket)</p>  | <p>Reference 6Y4903RESET90</p>   |

## Main references (usually available from stock\*)

| References         | Open (°C/ °F) | Tolerance (°C/ °F) | Bracket style | Bracket material | Terminal style | Terminal to bracket hole angle |
|--------------------|---------------|--------------------|---------------|------------------|----------------|--------------------------------|
| 4R05EJ050RMDCSV047 | 50°C/ 122°F   | ±4°C/ ±39.2°F      | 1             | SS               | G              | N/ A                           |
| 4R05EJ055RMCCSVF44 | 55°C/ 131°F   | ±3°C/ ±37.4°F      | 4             | SS               | G              | 45°                            |
| 4R05EJ055RMCCSVF41 | 55°C/ 131°F   | ±3°C/ ±37.4°F      | 4             | SS               | G              | 135°                           |
| 4R05EJ065RMDCSVF44 | 65°C/ 149°F   | ±4°C/ ±39.2°F      | 4             | SS               | G              | 45°                            |
| 4R05EJ070RMDCSV47  | 70°C/ 158°F   | ±4°C/ ±39.2°F      | 2             | SS               | G              | N/ A                           |
| 4R05EJ075RMDCSV47  | 75°C/ 167°F   | ±4°C/ ±39.2°F      | 2             | SS               | G              | N/ A                           |
| 4R05EJ075RMDCSVF44 | 75°C/ 167°F   | ±4°C/ ±39.2°F      | 4             | SS               | G              | 45°                            |
| 4R05EJ085RMDCSVF44 | 85°C/ 185°F   | ±4°C/ ±39.2°F      | 4             | SS               | G              | 45°                            |
| 4R05EJ090RMDL6VM37 | 90°C/ 194°F   | ±4°C/ ±39.2°F      | 2             | AL               | A              | N/ A                           |
| 4R05EJ090RMDCSVF44 | 90°C/ 194°F   | ±4°C/ ±39.2°F      | 4             | SS               | G              | 45°                            |
| 4R05EJ120RMDCSVF44 | 120°C/ 248°F  | ±4°C/ ±39.2°F      | 4             | SS               | G              | 45°                            |
| 4R05NJ150RMEL6HM37 | 150°C/ 302°F  | ±6°C/ ±42.8°F      | 2             | AL               | B              | N/ A                           |

\* Products usually available from stock in one of the Ultimheat Alliance members.



# Manual reset and thermal cut-out

## Epoxy potted waterproof manual reset disc thermostat, 2 wire output.

### Type 4REMR

#### Dimensions

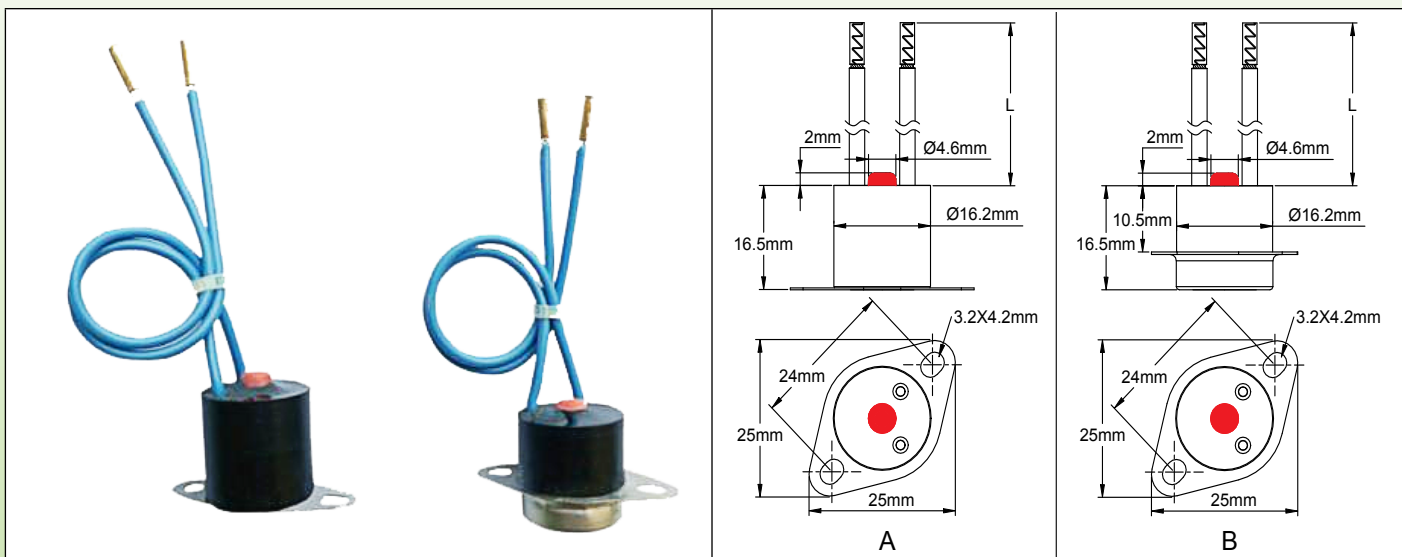

#### Applications

Manual reset safety thermostats, for applications where there are risks of condensation or water drops. The thermostat body, **including the cup crimping zone**, is inside an epoxy potting. The manual reset button is accessible by a small silicone cap partially embedded in the epoxy resin. The 2 wire output, in addition to protection against ingress of water, also protects users against accidental contact with live terminals.

#### Main features

**Thermostat Housing:** High temperature black epoxy, diameter 16.2mm. Good UV resistance. Excellent wire pull strength. Maximum ambient temperature 120°C.

**Temperature sensing cup:** Stainless steel, not over-molded to improve temperature measurement. (Achievable in aluminum on request)

**Contact:** SPNC, open on temperature rise.

**Reset:** Manual

**Electrical rating:** 10A resistive, 250VAC, 1000 cycles.

**Wires:** XLPE insulated, 300V, AWG16 (1.5mm<sup>2</sup>), stranded, temperature resistance 125°C, according to UL3266.

**Wire terminations:** Stripped on 6mm (wire end terminals or other terminals on request)

**Calibration temperatures:** Available on request from 40 to 120°C. Standard tolerances +/- 5°C. MOQ 1000 pieces applicable for specific values.

**Product identification:** Reference label on the wires and coded date on the thermostat cup

**Mounting:** Two modes: Flat bracket (type A) for measuring surface temperature, or extended cup bracket (type B) for through wall measurement.

#### Main references with 1 meter wires, T125°C XLPE, AWG16 (1.5mm<sup>2</sup>)

| References       | Open         | Tolerance    | Bracket style | Bracket material |
|------------------|--------------|--------------|---------------|------------------|
| 4REMRR055DBSY100 | 55°C/ 131°F  | ±3°C/ ±5.4°F | B             | Stainless steel  |
| 4REMRR065DBSY100 | 65°C/ 149°F  | ±4°C/ ±7.2°F | B             | Stainless steel  |
| 4REMRR075DBSY100 | 75°C/ 167°F  | ±4°C/ ±7.2°F | B             | Stainless steel  |
| 4REMRR085DBSY100 | 85°C/ 185°F  | ±4°C/ ±7.2°F | B             | Stainless steel  |
| 4REMRR090DBSY100 | 90°C/ 194°F  | ±4°C/ ±7.2°F | B             | Stainless steel  |
| 4REMRR120DBSY100 | 120°C/ 248°F | ±4°C/ ±7.2°F | B             | Stainless steel  |

Because of permanent improvement of our products, drawings, descriptions, features used on these data sheets are for guidance only and can be modified without prior advice



# Manual reset and thermal cut-out

## 3 poles manual reset disc thermostat.

### Type 4C

#### Dimensions

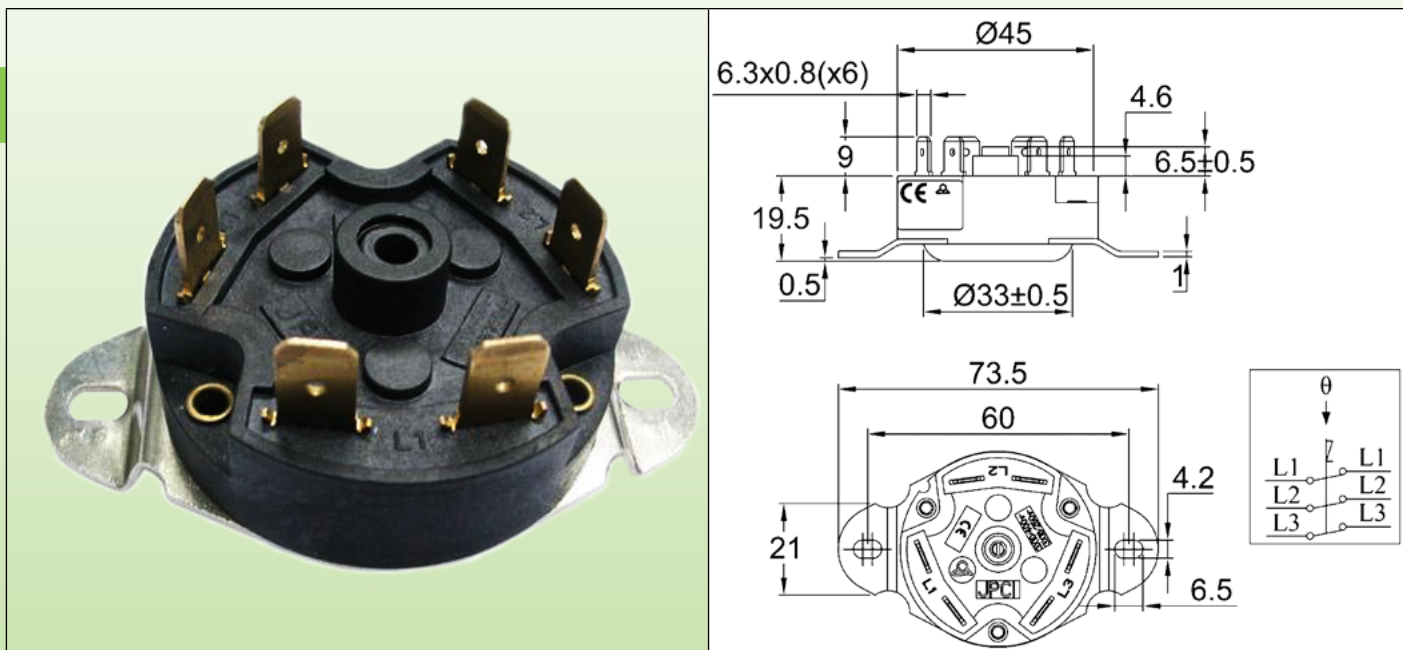

#### Technical features

**Applications:** Temperature limit of heaters, instant water heaters, saunas steam generators, industrial heaters

**Housing dimensions:** Diameter 45mm, height 20mm (28mm with terminals),

**Body material:** High temperature PPS

**Temperature sensing element:** Bimetal disc

**Terminals:** 6.35 × 0.8mm quick connect

**Set point temperature range:** +20 to +180°C (Factory fixed setting only)

**Mounting:** Surface mounting fixed bracket, 2 holes 4.4 × 6.4mm, 60mm distance

**Rating:** 3 × 16A 250VAC, 3 × 10A 400VAC, resistive (10000 cycles)

3 × 25A 250VAC, 3 × 16A 400VAC (300 cycles)

**Contact:** 3 snap action contacts, double break, open on temperature rise.

**Max ambient temperature:** 180°C(356°F)

**Approvals:** Comply with EN 60730-1 and EN 60730-2 standards (CE mark)

#### Main references

| References       | Operating Temperature (°C/°F) | Tolerance (°C/°F) | References       | Operating Temperature (°C/°F) | Tolerance (°C/°F) |
|------------------|-------------------------------|-------------------|------------------|-------------------------------|-------------------|
| 4C504T070RMEM60D | 70°C/ 158°F                   | ±4°C/ ±39.2°F     | 4C504T105RMEM60D | 105°C/ 221°F                  | ±6°C/ ±42.8°F     |
| 4C504T075RMEM60D | 75°C/ 167°F                   | ±4°C/ ±39.2°F     | 4C504T110RMEM60D | 110°C/ 230°F                  | ±6°C/ ±42.8°F     |
| 4C504T080RMEM60D | 80°C/ 176°F                   | ±5°C/ ±41°F       | 4C504T120RMEM60D | 120°C/ 248°F                  | ±6°C/ ±42.8°F     |
| 4C504T085RMEM60D | 85°C/ 185°F                   | ±5°C/ ±41°F       | 4C504T130RMEM60D | 130°C/ 266°F                  | ±6°C/ ±42.8°F     |
| 4C504T090RMEM60D | 90°C/ 194°F                   | ±5°C/ ±41°F       | 4C504T140RMEM60D | 140°F/ 284°F                  | ±7°C/ ±44.6°F     |
| 4C504T095RMEM60D | 95°C/ 203°F                   | ±5°C/ ±41°F       | 4C504T150RMGM60D | 150°C/ 302°F                  | ±7°C/ ±44.6°F     |
| 4C504T100RMEM60D | 100°C/ 212°F                  | ±5°C/ ±41°F       | 4C504T160RMEM60D | 160°C/ 320°F                  | ±7°C/ ±44.6°F     |

#### Accessories

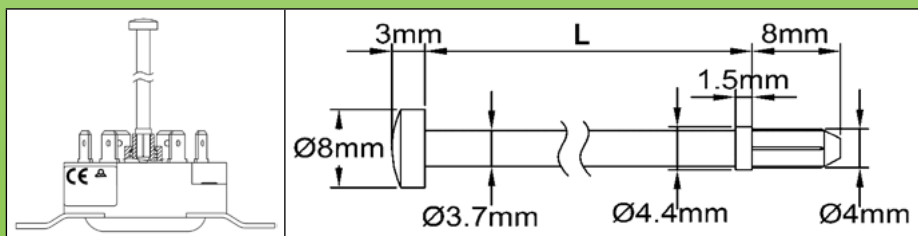

Long distance manual reset rods

| L   | Reference |
|-----|-----------|
| 114 | 664CLR114 |
| 30  | 664CLR030 |

Other length on request





# Manual reset and thermal cut-out

## Single pole manual reset limiter, bulb and capillary, SPDT contact

### Type KZ-3

#### Dimensions

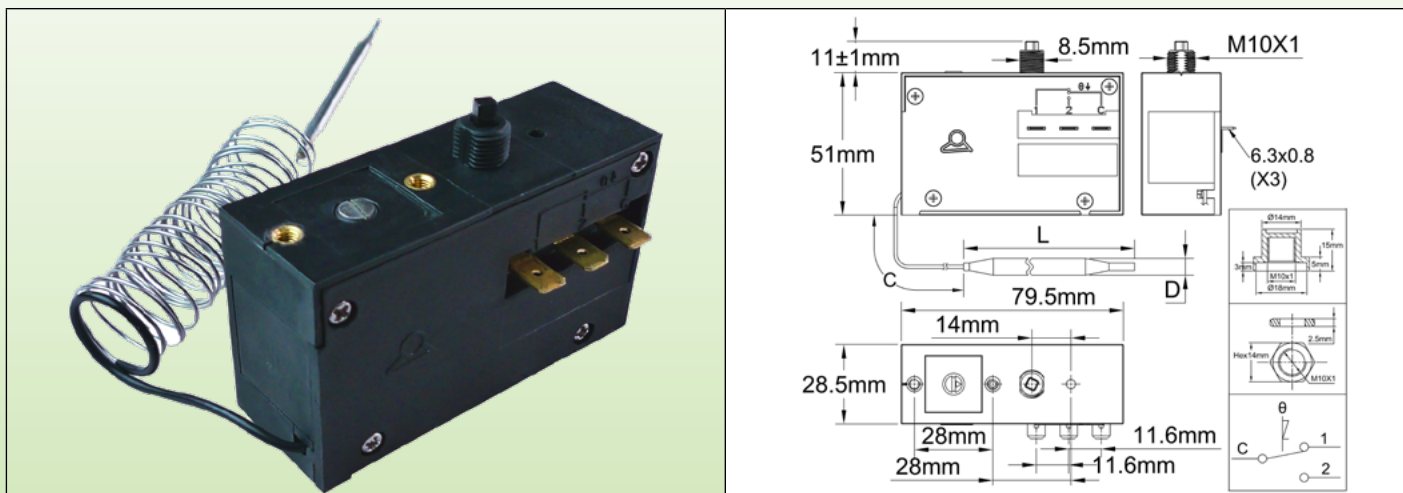

**Housing dimensions:** 79.5 × 51 × 28.5mm (6.3 quick connect terminals and manual reset button not included)

**Bulb and capillary:** Copper or stainless steel depending on temperature range, standard capillary length 1500mm. Capillary minimum bending radius 5mm.

**Temperature sensing element:** Liquid filled bulb and capillary.

**Terminals:** 3 tabs 6.35 × 0.8mm

**Adjustment:** Non-adjustable set point, factory sealed

**Mounting:** By 2 M4 screws, 28mm distance or by M10 × 1 bushing.

**Rating:** 16A (¼ HP) 250VAC, 16A 400V res.

**Contact:** SPDT (snap action contact), manual reset

**Electrical life:** >100,000 cycles at nominal rating.

**Accessories:** M10 × 1 nut and manual reset cap are included.

**Options:** Fixed setting can be replaced by screw driver with limited adjustment possibilities.

#### Main references

| References    | Possible calibration span (°C/ °F) | Capillary length (C, mm) | Bulb diameter (D, mm) | Bulb length (L, mm) | Max temperature on bulb (°C/ °F) |
|---------------|------------------------------------|--------------------------|-----------------------|---------------------|----------------------------------|
| KZF050***230V | 0-50°C (32-120°F)                  | 1500                     | 6.4                   | 152                 | 60°C (140°F)                     |
| KZF050***530V | 10-150°C (50-300°F)                | 1500                     | 4.8                   | 130                 | 160°C (320°F)                    |
| KZF050***130V | 10-150°C (50-300°F)                | 3000                     | 4.8                   | 130                 | 160°C (320°F)                    |
| KZF050***030V | 50-300°C (120-570°F)               | 1500                     | 4                     | 100                 | 320°C (610°F)                    |
| KZF050***730V | 60-500°C (140-930°F)               | 1500                     | 4.8                   | 120                 | 760°C (1400°F)                   |
| KZF050***930V | 60-500°C (140-930°F)               | 3000                     | 4.8                   | 120                 | 760°C (1400°F)                   |

\*\*\* = Calibration value in °C

Caution: Bulbs and capillaries of ranges above 400°C are filled with sodium potassium eutectic. If they leak or are broken, this liquid will ignite if in contact with water.

Because of permanent improvement of our products, drawings, descriptions, features used on these data sheets are for guidance only and can be modified without prior advice



# Manual reset and thermal cut-out

## SPNC manual reset high limit, fail safe.

### Type 8L

#### Dimensions

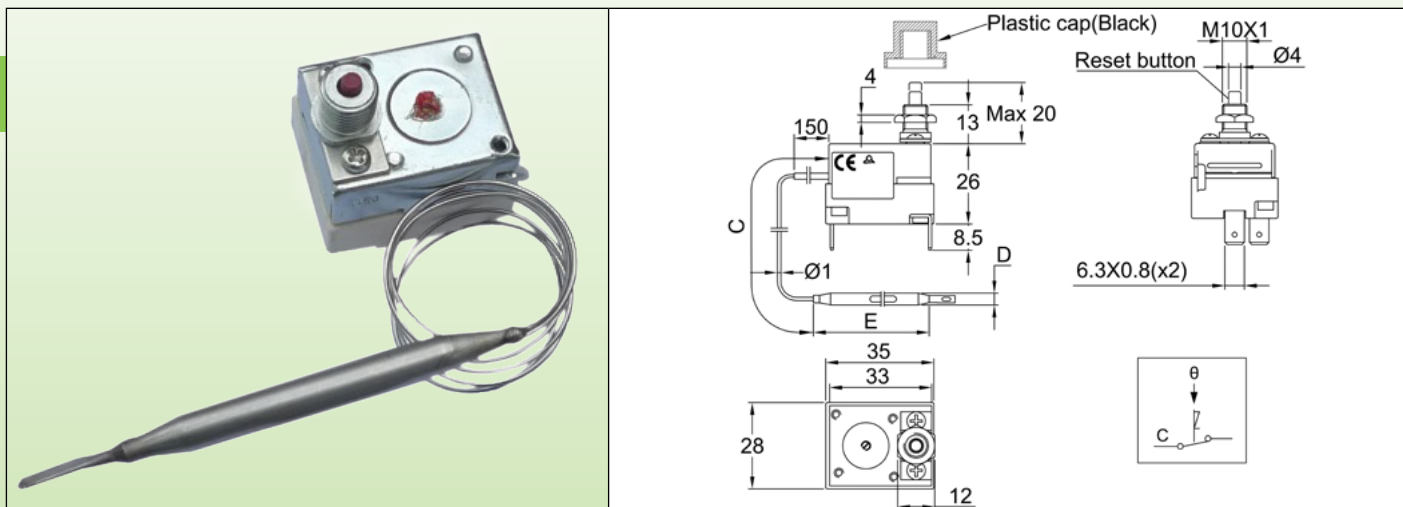

#### Technical features

**Applications:** Protection against the overheating of the heaters due to an abnormal rise of the liquid temperature due to a flow failure. The mounting of the bulbs can be made inside standard dia. 8.5mm pockets, or in an additional thermowell added on request. The thermostat body can be installed in a protective cover of the heating elements outputs, or remotely in a separate control cabinet. They are resettable after tripping, but prior full audit of the circuit is essential to find the cause of overheating and correct it before restarting.

**Housing dimensions:** 43 × 35 × 29mm (without terminals).

**Bulb and capillary:** Stainless steel, capillary length 250mm or 1500mm, 150mm long PVC sleeve on capillary. Capillary minimum bending radius 5mm.

**Temperature sensing element:** Liquid filled bulb and capillary.

**Terminals:** 6.35 × 0.8 quick connect terminals (M4 screws also available on request).

**Adjustment:** Fixed setting, sealed.

**Manual reset:** Fail safe, fixed setting, front access reset button.

**Fail safe contact action by low temperature:** Temperatures under -10°C (14°F) will trigger the manual reset.

**Mounting:** Front bushing , M10 × 1 thread

**Rating:** 16A 250/ 400VAC

**Contacts:** SPST (snap action contact)

**Max ambient temperature on body:** 150°C (302°F)

#### Main references

| Reference        | Calibration Temperature (°C/ °F) | Minimum resettable temperature (°C/ °F) | Capillary length (mm) | Bulb diameter (mm) | Bulb length (mm) | Max temperature on bulb (°C/ °F) |
|------------------|----------------------------------|---|-----------------------|--------------------|------------------|----------------------------------|
| 8L0070105AO61001 | 70±8°C/ 158±14.4°F               | 52°C/ 125.6°F                           | 1500                  | 6                  | 77               | 105°C/ 239°F                     |
| 8L0080105AA61001 | 70±8°C/ 158±14.4°F               | 52°C/ 125.6°F                           | 250                   | 6                  | 77               | 105°C/ 239°F                     |
| 8L0080105AO61001 | 80±8°C/ 176±14.4°F               | 52°C/ 125.6°F                           | 1500                  | 6                  | 77               | 105°C/ 239°F                     |
| 8L0080105AA61001 | 80±8°C/ 176±14.4°F               | 52°C/ 125.6°F                           | 250                   | 6                  | 77               | 105°C/ 239°F                     |
| 8L0090115AO61001 | 90±8°C/ 194±14.4°F               | 60°C/ 140°F                             | 1500                  | 6                  | 77               | 115°C/ 239°F                     |
| 8L0090115AA61001 | 90±8°C/ 194±14.4°F               | 60°C/ 140°F                             | 250                   | 6                  | 77               | 115°C/ 239°F                     |
| 8L0100120AO61001 | 100±8°C/ 212±14.4°F              | 70°C/ 158°F                             | 1500                  | 6                  | 77               | 120°C/ 248°F                     |
| 8L0100120AA61001 | 100±8°C/ 212±14.4°F              | 70°C/ 158°F                             | 250                   | 6                  | 77               | 120°C/ 248°F                     |
| 8L0110135AO61001 | 110±8°C/ 230±14.4°F              | 75°C/ 167°F                             | 1500                  | 6                  | 77               | 135°C/ 275°F                     |
| 8L0110135AA61001 | 110±8°C/ 230±14.4°F              | 75°C/ 167°F                             | 250                   | 6                  | 77               | 135°C/ 275°F                     |
| 8L0120145AO61001 | 120±8°C/ 248±14.4°F              | 75°C/ 167°F                             | 1500                  | 6                  | 77               | 145°C/ 293°F                     |
| 8L0120145AA61001 | 120±8°C/ 248±14.4°F              | 75°C/ 167°F                             | 250                   | 6                  | 77               | 145°C/ 293°F                     |
| 8L0130155AO61001 | 130±8°C/ 266±14.4°F              | 80°C/ 176°F                             | 1500                  | 6                  | 74               | 155°C/ 311°F                     |
| 8L0130155AA61001 | 130±8°C/ 266±14.4°F              | 80°C/ 176°F                             | 250                   | 6                  | 74               | 155°C/ 311°F                     |
| 8L0150175AO61001 | 150±8°C/ 302±14.4°F              | 95°C/ 203°F                             | 1500                  | 6                  | 74               | 175°C/ 347°F                     |
| 8L0150175AA61001 | 150±8°C/ 302±14.4°F              | 95°C/ 203°F                             | 250                   | 6                  | 74               | 175°C/ 347°F                     |



# Manual reset and thermal cut-out

## DPNC manual reset high limit, fail safe.

### Type 8X

#### Dimensions

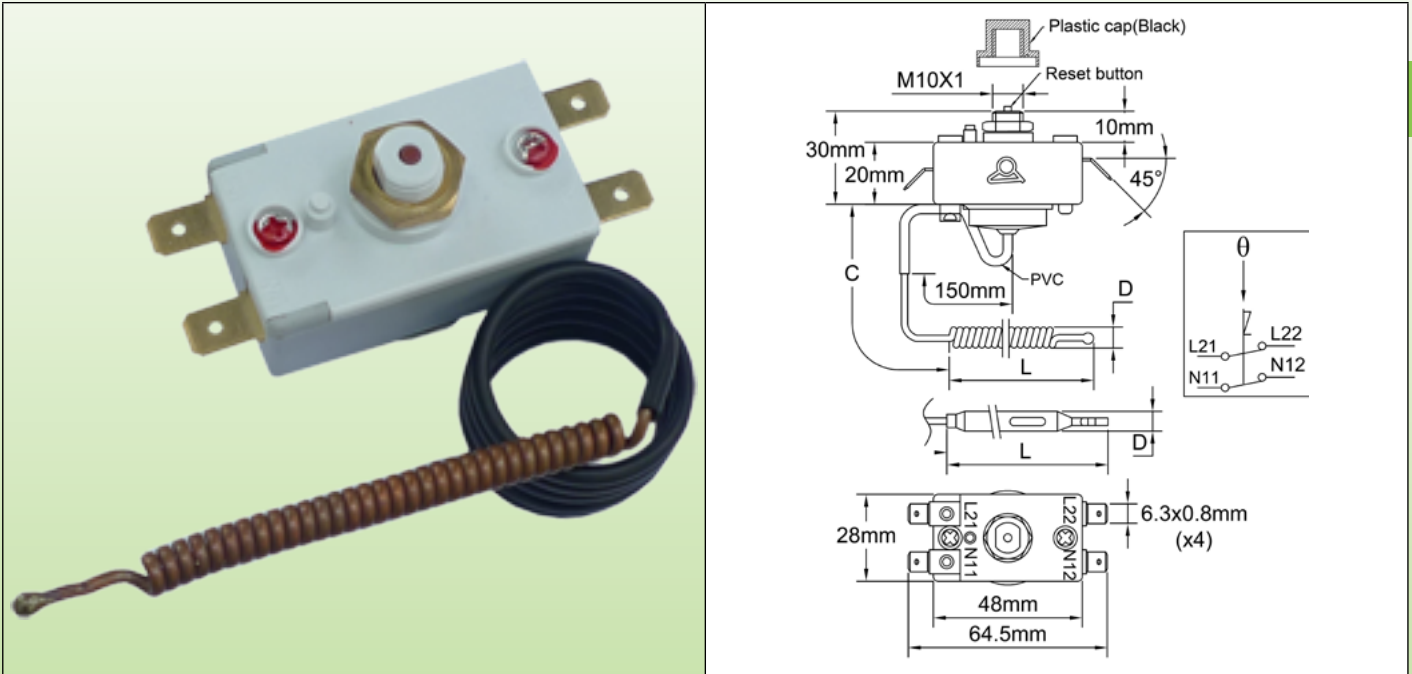

#### Technical features

**Housing dimensions:** 43 × 35 × 29mm (without terminals and diaphragm)

**Capillary:** Copper, capillary length 250mm or 900mm, 150mm long PVC sleeve on capillary. Capillary minimum bending radius 5mm.

For technical reasons, we do not recommend to use capillary length longer than 900mm.

**Bulb:** Copper, corkscrew type for temperatures from 60 to 130°C (140 to 266°F), tubular dia 6mm from 130°C to 170°C (266 to 338°F).

**Temperature sensing element:** Liquid-filled thermostatic assembly whose boiling causes tripping of the contact. Therefore, unlike liquid filled systems, these thermostats are sensitive to atmospheric pressure, and their reaction time is slower.

**Terminals:** 6.35 × 0.8 quick connect terminals

**Adjustment:** Fixed setting

**Mounting:** Front bushing, with M10 × 1

**Manual reset:** Fail safe action, front access button

**Rating:** 20A 250VAC

**Contacts:** DPST (snap action contact)

**Max ambient temperature on head:** 125°C (257°F)

#### Main references

| Reference        | Calibration Temperature (°C/ °F) | Minimum resettable temperature (°C/°F) | Capillary length (mm) | Bulb diameter (mm) | Bulb length (mm) | Max temperature on bulb (°C/ °F) |
|------------------|----------------------------------|--|-----------------------|--------------------|------------------|----------------------------------|
| 8X0060090CI610F1 | 60±5°C/ 140±41°F                 | 20°C/ 68°F                             | 900                   | 6                  | 50               | 90°C/ 194°F                      |
| 8X0060090CA610F1 | 60±5°C/ 140±41°F                 | 20°C/ 68°F                             | 250                   | 6                  | 50               | 90°C/ 194°F                      |
| 8X0070100CI610F1 | 70±5°C/ 158±41°F                 | 30°C/ 86°F                             | 900                   | 6                  | 50               | 100°C/ 212°F                     |
| 8X0080110CI610F1 | 80±5°C/ 176±41°F                 | 40°C/ 104°F                            | 900                   | 6                  | 50               | 110°C/ 230°F                     |
| 8X0090120CI610F1 | 90±5°C/ 194±41°F                 | 50°C/ 122°F                            | 900                   | 6                  | 50               | 120°C/ 248°F                     |
| 8X0110140CI610F1 | 110±5°C/ 230±41°F                | 70°C/ 158°F                            | 900                   | 6                  | 50               | 140°C/ 284°F                     |
| 8X0130160CI610F1 | 130±6°C/ 266±42.8°F              | 90°C/ 194°F                            | 900                   | 6                  | 60*              | 160°C/ 320°F                     |
| 8X0150180CI610F1 | 150±7°C/ 302±44.6°F              | 110°C/ 230°F                           | 900                   | 6                  | 60*              | 180°C/ 356°F                     |
| 8X0170200CI610F1 | 170±7°C/ 338±44.6°F              | 130°C/ 266°F                           | 900                   | 6                  | 60*              | 200°C/ 392°F                     |

\* Cylinder bulb



# Manual reset and thermal cut-out

## 3 poles manual reset high limit, fail safe

### Type 82

#### Dimensions

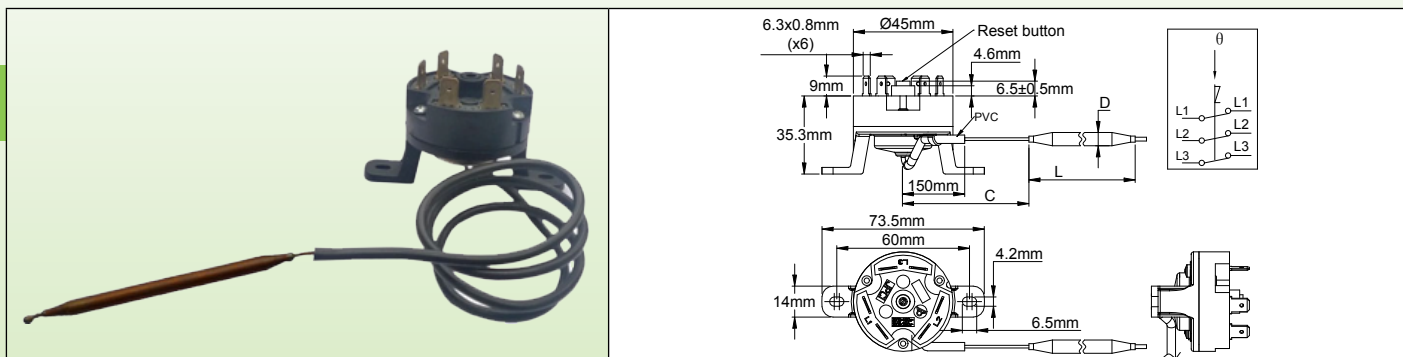

#### Technical features

**Applications:** Protection against the overheating of the heaters due to an abnormal rise of the liquid temperature due to a flow failure. The mounting of the bulbs can be made inside standard dia. 8.5mm pockets, or in an additional thermowell added on request. The thermostat body can be installed in a protective cover of the heating elements outputs, or remotely in a separate control cabinet. They are resettable after tripping, but prior full audit of the circuit is essential to find the cause of overheating and correct it before restarting.

**Housing dimensions:** Dia 45 × 44.3mm

**Capillary:** Copper, capillary length 250mm or 900mm, 150mm long PVC sleeve on capillary. Capillary minimum bending radius 5mm.

For technical reasons, we do not recommend to use capillary length longer than 900mm.

**Bulb:** Copper, dia. 6mm.

**Temperature sensing element:** Liquid-filled thermostatic assembly whose boiling causes tripping of the contact. Therefore, unlike liquid filled systems, these thermostats are sensitive to atmospheric pressure, and their reaction time is slower.

**Terminals:** 6.35 × 0.8 quick connect terminals

**Adjustment:** Fixed setting

**Mounting:** Backside legs, 2 M4 screws, holes distance 60mm

**Manual reset:** Fail safe action, center button

**Rating:** 3 × 16A 250VAC, 3 × 10A 400VAC, resistive (10000 cycles), 3 × 25A 250VAC, 3 × 16A 400VAC (300 cycles)

**Contacts:** Three poles, open on temperature rise (snap action contact), double break.

**Max ambient temperature on head:** 150°C(302°F)

#### Main references

| Reference        | Calibration Temperature (°C/ °F) | Minimum resettable temperature (°C/ °F) | Capillary length (mm) | Bulb diameter (mm) | Bulb length (mm) | Max temperature on bulb (°C/ °F) |
|------------------|----------------------------------|---|-----------------------|--------------------|------------------|----------------------------------|
| 820060090CI610F1 | 60±5°C/ 140±9°F                  | 20°C/ 68°F                              | 900                   | 6                  | 50               | 90°C/ 194°F                      |
| 820060090CA610F1 | 60±5°C/ 140±9°F                  | 20°C/ 68°F                              | 250                   | 6                  | 50               | 90°C/ 194°F                      |
| 820070100CI610F1 | 70±5°C/ 158±9°F                  | 30°C/ 86°F                              | 900                   | 6                  | 50               | 100°C/ 212°F                     |
| 820080110CI610F1 | 80±5°C/ 176±9°F                  | 40°C/ 104°F                             | 900                   | 6                  | 50               | 110°C/ 230°F                     |
| 820090120CI610F1 | 90±5°C/ 194±9°F                  | 50°C/ 122°F                             | 900                   | 6                  | 50               | 120°C/ 248°F                     |
| 820110140CI610F1 | 110±5°C/ 230±9°F                 | 70°C/ 158°F                             | 900                   | 6                  | 50               | 140°C/ 284°F                     |
| 820130160CI610F1 | 130±6°C/ 266±11°F                | 90°C/ 194°F                             | 900                   | 6                  | 60*              | 160°C/ 320°F                     |
| 820150180CI610F1 | 150±7°C/ 302±13°F                | 110°C/ 230°F                            | 900                   | 6                  | 60*              | 180°C/ 356°F                     |
| 820170200CI610F1 | 170±7°C/ 338±13°F                | 130°C/ 266°F                            | 900                   | 6                  | 60*              | 200°C/ 392°F                     |

\* Cylinder bulb

#### Accessories

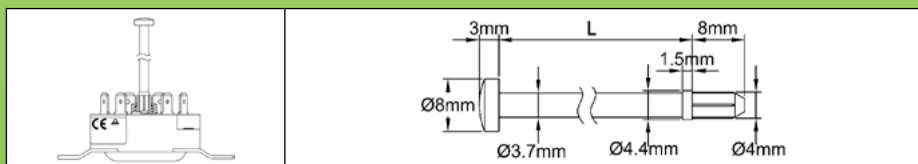

Long distance manual reset rods

| L   | Reference |
|-----|-----------|
| 114 | 664CLR114 |
| 30  | 664CLR030 |

Other length on request



# Manual reset thermal cut-out

## 3 poles manual reset high limit, fail safe

### Type 85

#### Dimensions

Because of permanent improvement of our products, drawings, features used on these data sheets are for guidance only and can be modified without prior advice

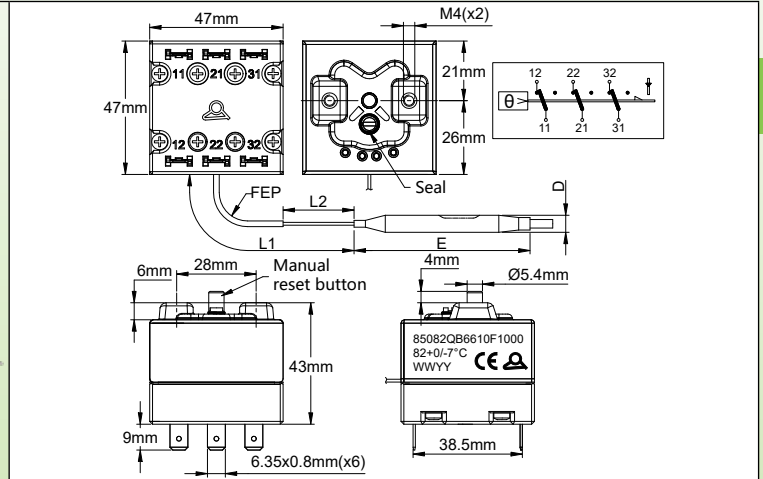
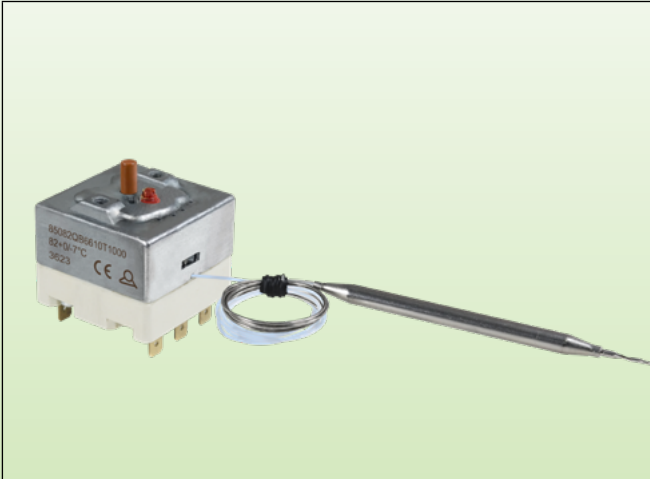

Type with 2 M4 screws mounting

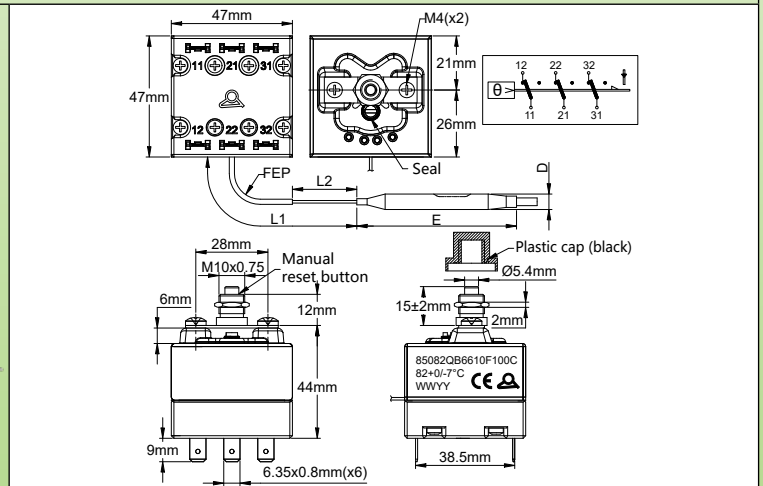
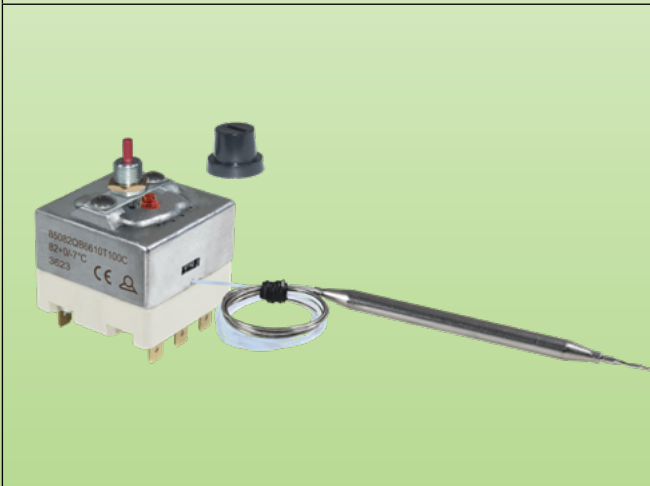

Type with M10 central bush mounting

#### Technical features

##### Housing dimensions:

- Two M4 screws, 28mm distance mounting: 47 × 47 × 43 mm (terminals not included).
- Type with M10 central bush mounting: 47 × 47 × 56 mm (terminals not included).

**Bulb and capillary:** Stainless steel, capillary length 250mm to 1,500mm with 150 mm long FEP sleeve on capillary or 1000 mm with 900 mm long FEP sleeve on capillary. Capillary minimum bending radius 5 mm.

**Temperature sensing element:** Liquid filled bulb and capillary.

**Terminals:** 6.35 × 0.8 quick connect terminals (M4 screw with saddle also available on request).

**Adjustment:** Fixed setting, sealed.

**Manual reset:** Fail safe, fixed setting, front access reset button.

**Fail safe contact action by low temperature:** Temperature under -15°C (5°F) will trigger the manual reset. Then it is possible to manually reset the contacts when temperature resumes to normal.

**Mounting:** 2 screws M4, 28mm distance. (Front bushing, M10 × 0.75 thread available on request)

**Rating:** 30A 250/400VAC resistive.

**Contacts:** 3 snap action simultaneous contact, open on temperature rise.

**Max ambient temperature on body:** 125°C (257°F).

**Other technical features:** Ask for technical data sheet of the specific product.

##### Options:

- M14 fitting on capillary (for water baths and deep fryers).
- Central M10 bush mounting.
- 1, 2, or 3 gold plated contacts for thermocouple circuits or electronic low voltage devices.

**Approvals:** CE (by TÜV).



# Manual reset thermal cut-out

Main references, without capillary fitting\*, 2 M4 screws mounting\*\*

| Reference        | Calibration temperature °C (°F) | Capillary length (mm) | Bulb diameter (mm) | Bulb length (mm) | Max temperature on bulb (°C/°F) |
|------------------|---------------------------------|-----------------------|--------------------|------------------|---------------------------------|
| 85080QB6610TF000 | 80+0/-7°C (176+0/-13°F)         | 1000                  | 6                  | 60               | 270°C/518°F                     |
| 85080QB66BETF000 | 80+0/-7°C (176+0/-13°F)         | 250                   | 6                  | 60               | 270°C/518°F                     |
| 85090QB6610TF000 | 90+0/-7°C (194+0/-13°F)         | 1000                  | 6                  | 60               | 270°C/518°F                     |
| 85100QB6610TF000 | 110+0/-10°C (230+0/-18°F)       | 1000                  | 6                  | 60               | 270°C/518°F                     |
| 85130QB6510TF000 | 130+0/-10°C (266+0/-18°F)       | 1000                  | 6                  | 55               | 270°C/518°F                     |
| 85150QB6510TF000 | 150+0/-15°C (302+0/-27°F)       | 1000                  | 6                  | 55               | 270°C/518°F                     |
| 85175QB4410TF000 | 175+0/-15°C (347+0/-27°F)       | 1000                  | 4                  | 45               | 270°C/518°F                     |
| 85220QB4410TF000 | 220+0/-15°C (428+0/-27°F)       | 1000                  | 4                  | 40               | 270°C/518°F                     |
| 85270QB4410TF000 | 270+0/-20°C (518+0/-36°F)       | 1000                  | 4                  | 40               | 295°C/563°F                     |
| 85300QB4410TF000 | 300+0/-20°C (572+0/-36°F)       | 1000                  | 4                  | 40               | 325°C/617°F                     |

Other temperatures and capillary length on request.

\* - With 120°C (248°F) capillary fitting for Bain Marie, replace 000 by 300 in the reference

- With 220°C (428°F) capillary fitting for deep fryers, replace 000 by 400 in the reference

\*\* -With M10x0.75 central bush fixing, replace the last character 0 by C in the reference

## Capillary fittings, shipped assembled on the capillary

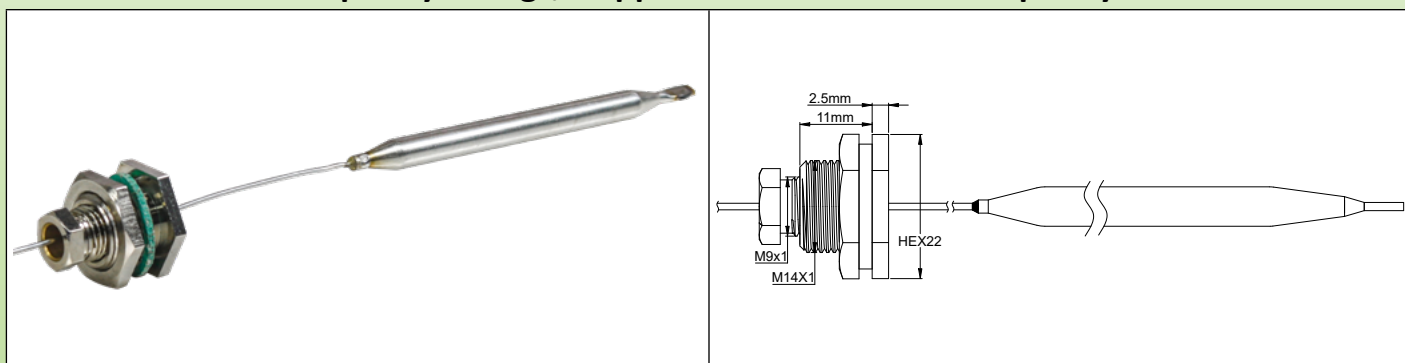

Because of permanent improvement of our products, drawings, descriptions, features used on these data sheets are for guidance only and can be modified without prior advice



# Manual reset and thermal cut-out

## Thermal cut outs, 10 and 16A 250V, axial wires, Type 5MA3

### Dimensions

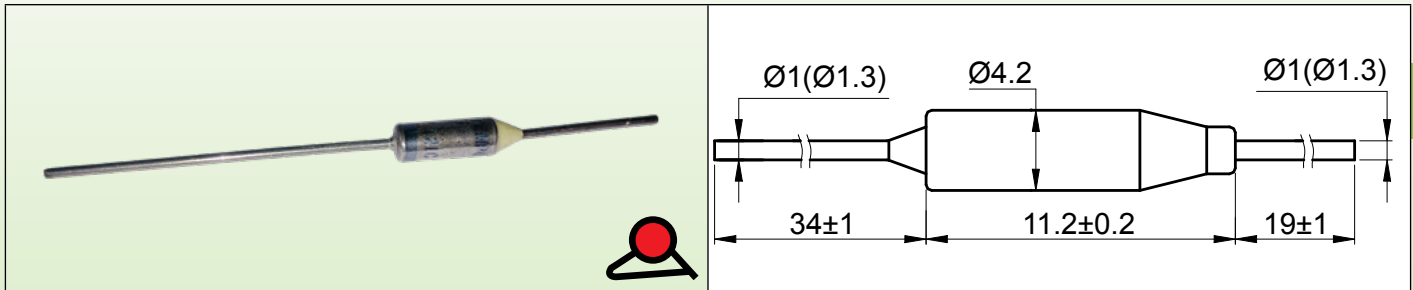

### Technical features

**Main application:** Overheat protection of electrical or electronic equipment, home appliances, electrical coils and heating components.

**Important notice:** The proper function of this component not only depends of its rated temperature, but also of its assembly position, connection and electrical current.

**Housing:** Silver plated copper. This is a non-insulated electric life part. Protect from human contact and use appropriate design to avoid electrical shocks and hazards. Do not bend or make holes in housing.

**Ingress protection:** TCO are not waterproof, do not immerse in liquid.

**Insulation:** 95% alumina, epoxy sealed. Do not submit epoxy sealing to temperature over 200°C.

**Melting pellet:** Organic compound.

**Mechanism type:** Spring operated movable contact, operated by the melting pellet.

**Terminals:** Tin plated copper wires.

#### Wiring rules:

**Mechanical resistance:** Do not submit TCO wires to pulling force over 16N or pushing force over 4N.

**Bending:** Do not bend or cut wires at less than 6mm from epoxy sealing or housing.

**Crimping:** Do not submit to impact or mechanical force during terminals crimping. Wrong crimping will overheat the wire by Joule effect, fuse will melt, and epoxy seal will burn down.

Parts crimped to TCO wires must with have enough mechanical strength and hardness to withstand normal vibration and impact, and it must not cause stresses due to heat dilatation.

**Tin welding:** It is not allowed to use tin welding for fuse with rated temperature under 184°C without proper wire cooling solution to avoid fuse to melt.

**Electrical welding:** Proper wire cooling solution must be used to avoid fuse to melt wire, and welding current cannot go through the fuse;

**Shrinkable sleeves:** Do not use shrinkable sleeves, it will melt down the TCO during the shrinking process.

**Environment corrosion:** TCO must be protected from corrosive environment, air or fumes.

**Rated voltage:** 250V(AC)

**Rated current:** 10A and 16A (2 different types).

The rated current is the max current that the TCO can carry without opening or change in calibration temperature, when submitted at a limited temperature named "Holding temperature" (Th), during a limited time.

**Rated temperature (Tf):** It is the fuse contact opening temperature measured inside calibration oven, with a current lower than 10 mA and a temperature rise of 0.5 to 1°C/ min. Opening temperature cannot be below Tf-10°C and not higher than Tf. It is this temperature that is printed on the TCO.

#### Holding temperature (Th):

TCO must not open or be destroyed when submitted during 168 hours at Th-6°C, at nominal voltage and rating

**Max ultimate temperature(Tm):** It is the maximum temperature that the fuse can withstand, after opening, without change in its mechanical and insulation properties.

**Electrical strength between contacts after opening:** ≥500V

**Insulation resistance between contacts after opening:** ≥0.2MΩ under 500 V.

**Joule effect temperature increase:** Lower than 15°C measured at the center of the fuse under nominal load.

**Standard:** DIN EN60691(VDE 0821): 2007-09

EN60691: 2003+A1: 2007.IEC60691(ed.3); am1

#### Product identification:

SPF169: Model number

TF172C: Rated operation temperature (Tf)

10A250V: Rated current and voltage

088: Production number

#### Installation and safety instructions:

- Choose TCO temperature fuse which electrical insulation will not be effected by equipment overheat.

- TCO replacement must be made by exactly the same model of the same supplier



# Manual reset and thermal cut-out

## Main references

| Reference with 10A rating | Reference with 16A rating | Rated functioning temperature °C/ °F (Tf) | Holding temperature °C/ °F (Th) | Maximum temperature °C/ °F (Tm) |
|---------------------------|---------------------------|---|---------------------------------|---------------------------------|
| 5MA3SPF070019340          | 5MA3SPF070H19340          | 73°C/ 163.4°F                             | 45°C/ 113°F                     | 115°C/ 239°F                    |
| 5MA3SPF077019340          | 5MA3SPF077H19340          | 79°C/ 174.2°F                             | 52°C/ 125.6°F                   | 125°C/ 257°F                    |
| 5MA3SPF084019340          | 5MA3SPF084H19340          | 85°C/ 185°F                               | 57°C/ 134.6°F                   | 125°C/ 257°F                    |
| 5MA3SPF091019340          | 5MA3SPF091H19340          | 94°C/ 201.2°F                             | 66°C/ 150.8°C                   | 140°C/ 284°F                    |
| 5MA3SPF096019340          | 5MA3SPF096H19340          | 99°C/ 210.2°F                             | 71°C/ 159.8°F                   | 140°C/ 284°F                    |
| 5MA3SPF106019340          | 5MA3SPF106H19340          | 108°C/ 226.4°F                            | 77°C/ 170.6°F                   | 145°C/ 293°F                    |
| 5MA3SPF109019340          | 5MA3SPF109H19340          | 113°C/ 235.4°F                            | 84°C/ 183.2°F                   | 150°C/ 302°F                    |
| 5MA3SPF121019340          | 5MA3SPF121H19340          | 122°C/ 251.6°F                            | 94°C/ 201.2°F                   | 175°C/ 347°F                    |
| 5MA3SPF129019340          | 5MA3SPF129H19340          | 133°C/ 271.4°F                            | 101°C/ 213.8°F                  | 175°C/ 347°F                    |
| 5MA3SPF139019340          | 5MA3SPF139H19340          | 142°C/ 287.6°F                            | 114°C/ 237.2°F                  | 185°C/ 365°F                    |
| 5MA3SPF152019340          | 5MA3SPF152H19340          | 157°C/ 314.6°F                            | 127°C/ 260.6°F                  | 195°C/ 383°F                    |
| 5MA3SPF165019340          | 5MA3SPF165H19340          | 167°C/ 332.6°F                            | 130°C/ 266°F                    | 205°C/ 401°F                    |
| 5MA3SPF169019340          | 5MA3SPF169H19340          | 172°C/ 341.6°F                            | 145°C/ 293°F                    | 215°C/ 419°F                    |
| 5MA3SPF182019340          | 5MA3SPF182H19340          | 184°C/ 363.2°F                            | 156°C/ 312.8°F                  | 225°C/ 437°F                    |
| 5MA3SPF188019340          | 5MA3SPF188H19340          | 192°C/ 377.6°F                            | 164°C/ 327.2°F                  | 245°C/ 473°F                    |
| 5MA3SPF216019340          | 5MA3SPF216H19340          | 216°C/ 420.8°F                            | 189°C/ 372.2°F                  | 280°C/ 536°F                    |
| 5MA3SPF227019340          | 5MA3SPF227H19340          | 227°C/ 440.6°F                            | 190°C/ 374°F                    | 295°C/ 563°F                    |
| 5MA3SPF240019340          | 5MA3SPF240H19340          | 240°C/ 464°F                              | 190°C/ 374°F                    | 305°C/ 581°F                    |

Because of permanent improvement of our products, drawings, descriptions, features used on these data sheets are for guidance only and can be modified without prior advice





# Manual reset and thermal cut-out

## Wired thermal fuses, for insertion into 8.5mm I.D. thermowells Type 5MA3-F

### Dimensions

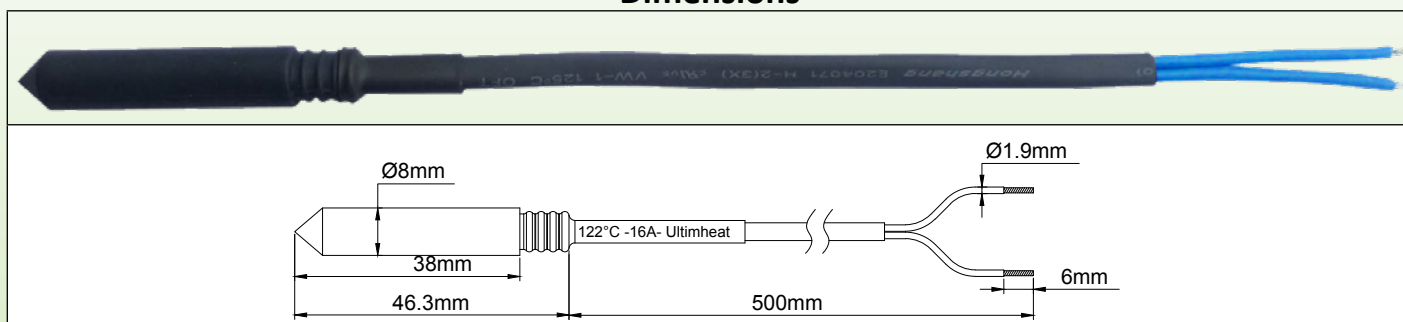

### Technical features

**Applications:** Protection against overheating of liquids heaters when dry run condition occurs. These thermal cut outs are designed to fit the pockets with 8.5 ID mounted in standard in the liquids heaters. It may be possible to replace them when they triggered, but it requires a prior full audit of all components of the heater because the important overheating due to lack of water may have damaged other components.

**Fusible pellet:** Organic compound.

**Mechanism:** Movable pellet actuated of a spring released by the fusion of the pellet.

**Protection:** By electrical insulation silicone boot, dia. 8mm.

**Locking in the pocket:** By silicone grommet

**Nominal current rating:** 16A 250V

The nominal current rating is the maximum current the fuse can carry without opening or deteriorate when subjected to a temperature known as the "holding temperature" (Th) for a limited time.

**Holding temperature (Th):** The fuse must not open or be destroyed when subjected to a temperature equal to Th-6°C for a period of 168 hours under nominal voltage and current.

**Rated functioning temperature (Tf):** It is the opening temperature of the fuse in a calibration oven, when subjected to a current less than 10 mA, when temperature rises at a speed of 0.5 to 1°C / min. The opening temperature must not be lower than Tf-10°C or above Tf under these conditions. This is the operating temperature Tf which is printed on the fuse and the protective sheath external of the leads.

**Maximum temperature (Tm):** It is the maximum temperature withstood by the fuse after opening without losing its insulating and mechanical properties.

**This feature is critical in liquids heaters application, to determine the right position of TCO to avoid its destruction and re-energization of the electrical circuit by high temperature overshoot.**

**Insulation voltage between open contacts:** ≥ 500V

**Insulation resistance between open contacts:** ≥ 0.2 MΩ @ 500V

**Lead lengths:** 500mm.

**Leads:** FEP 300V primary insulation, 1mm<sup>2</sup> gauge (AWG18), in a polyolefin sheath.

**In red:** Standard temperatures available from stock.

### Main references

| Reference        | Rated functioning temperature °C/ °F (Tf) | Holding temperature °C/ °F (Th) | Maximum temperature °C/ °F (Tm) |
|------------------|---|---------------------------------|---------------------------------|
| 5MA3SPF070F18500 | 73°C/ 163.4°F                             | 45°C/ 113°F                     | 115°C/ 239°F                    |
| 5MA3SPF077F18500 | 79°C/ 174.2°F                             | 52°C/ 125.6°F                   | 125°C/ 257°F                    |
| 5MA3SPF084F18500 | 85°C/ 185°F                               | 57°C/ 134.6°F                   | 125°C/ 257°F                    |
| 5MA3SPF091F18500 | 94°C/ 201.2°F                             | 66°C/ 150.8°F                   | 140°C/ 284°F                    |
| 5MA3SPF096F18500 | 99°C/ 210.2°F                             | 71°C/ 159.8°F                   | 140°C/ 284°F                    |
| 5MA3SPF106F18500 | 108°C/ 226.4°F                            | 77°C/ 170.6°F                   | 145°C/ 293°F                    |
| 5MA3SPF109F18500 | 113°C/ 235.4°F                            | 84°C/ 183.2°F                   | 150°C/ 302°F                    |
| 5MA3SPF121F18500 | 122°C/ 251.6°F                            | 94°C/ 201.2°F                   | 175°C/ 347°F                    |
| 5MA3SPF129F18500 | 133°C/ 271.4°F                            | 101°C/ 213.8°F                  | 175°C/ 347°F                    |
| 5MA3SPF139F18500 | 142°C/ 287.6°F                            | 114°C/ 237.2°F                  | 185°C/ 365°F                    |
| 5MA3SPF152F18500 | 157°C/ 314.6°F                            | 127°C/ 260.6°F                  | 195°C/ 383°F                    |
| 5MA3SPF165F18500 | 167°C/ 332.6°F                            | 130°C/ 266°F                    | 205°C/ 401°F                    |
| 5MA3SPF169F18500 | 172°C/ 341.6°F                            | 145°C/ 293°F                    | 215°C/ 419°F                    |
| 5MA3SPF182F18500 | 184°C/ 363.2°F                            | 156°C/ 312.8°F                  | 225°C/ 437°F                    |
| 5MA3SPF188F18500 | 192°C/ 377.6°F                            | 164°C/ 327.2°F                  | 245°C/ 473°F                    |
| 5MA3SPF216F18500 | 216°C/ 420.8°F                            | 189°C/ 372.2°F                  | 280°C/ 536°F                    |
| 5MA3SPF227F18500 | 227°C/ 440.6°F                            | 190°C/ 374°F                    | 295°C/ 563°F                    |
| 5MA3SPF240F18500 | 240°C/ 464°F                              | 190°C/ 374°F                    | 305°C/ 581°F                    |

Because of permanent improvement of our products, drawings, descriptions, features used on these data sheets are for guidance only and can be modified without prior advice



Because of permanent improvement of our products, drawings, descriptions, features used on these data sheets are for guidance only and can be modified without prior advice



Because of permanent improvement of our products, drawings, descriptions, features used on these data sheets are for guidance only and can be modified without prior advice

# Thermostat accessories













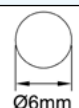
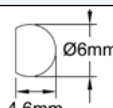
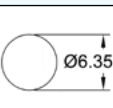
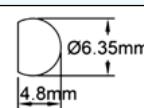
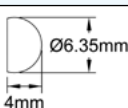





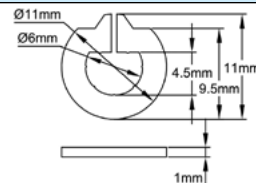
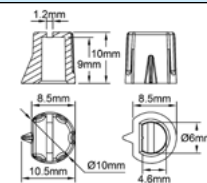
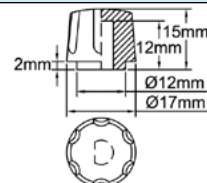
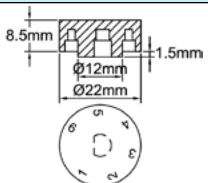





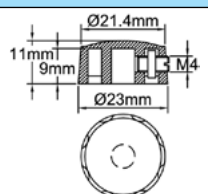
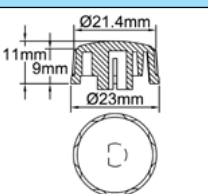
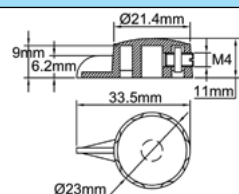
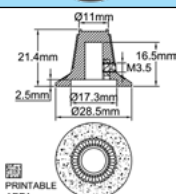
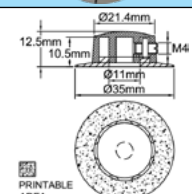

Because of permanent improvement of our products, drawings, descriptions, features used on these data sheets are for guidance only and can be modified without prior advice

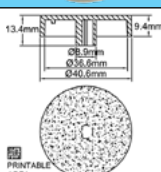
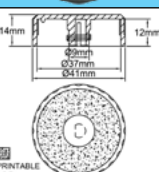
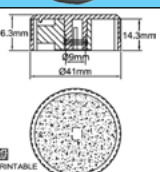
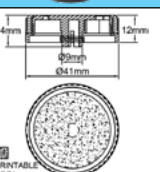

# Knobs for thermostats

## Main dimensions of adjustable thermostats shafts

For a correct use, a knob must be adapted to the dimensions of the shaft on which it is mounted

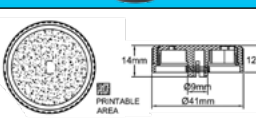
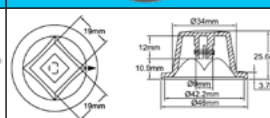
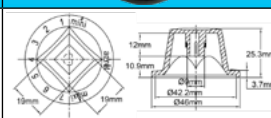
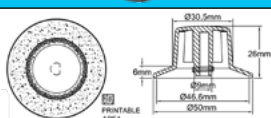
| <br>Dia. 4.75mm with 4mm flat (U.K) | <br>Dia. 6mm (Europe, Asia)                                | <br>Dia. 6mm with 4.6mm flat (Europe, Asia)         | <br>Dia. 6.35mm (UK, Northern America) | <br>Dia. 6.35mm with 4.8mm flat (UK, Northern America) | <br>Dia. 6.35mm with 4mm flat (UK, Northern America) |
|--|---|--|---|---|---|
| 66MN***  | 66MQ***   | 66MJ***  | 66MK***   | 66ML***   |   |
|                                     |    |   |                                      |    |   |
|                                      |    |   |                                       |    |   |
| Arrow style clips style, for dia. 6mm shaft with 4.6mm flat  | Ultra miniature knob for dia. 6mm with 4.6mm shaft, manual or screw driver adjustment   | Miniature knob for dia. 6mm shaft with 4.6mm flat  | Super slim line knob for dia. 6mm shaft with 4.6mm flat   | Slim line knob for dia. 6mm with 4.6mm shaft  |   |
| 66MA***  | 66MC***   | 66MI***  | 66MB***   | 66MH***   |   |
|                                     |    |   |                                      |    |   |
|                                    |   |    |                                      |   |   |
| Miniature knob for round dia. 6mm or 6.35mm shaft, screw clamping  | Miniature knob with pointer for dia.6mm shaft with 4.6mm flat   | Miniature knob with pointer for round dia. 6mm shaft, screw clamping   | High temperature knob for round dia. 6.35mm shaft, screw clamping   | Miniature knob for round shafts dia. 6mm or 6.35mm, with printable transparent skirt  |   |
| 66MM***  | 66MR***   | 66MG***  | 66ME***   | 66MS***   |   |
|                                   |    |   |                                    |    |   |
|                                   |    |   |                                    |    |   |
| Miniature knob for dia. 6mm shaft with 4.6mm flat, with printable transparent skirt                                  | Flat printable knob for 6.35 dia shaft with 4mm flat, clips clamping  | Medium temperature, PA66, flat printable knob for 6mm dia shaft with 4.6mm flat, clips clamping                                      | ABS flat printable knob for 6mm dia. shaft with 4.6mm flat, clips clamping, adjustable stop                             | Polycarbonate with soft grip touch knob, for 6mm dia. shaft with 4.6mm flat, clips clamping, with backlit                                 |   |
| 66MZ***  | 66MF***   | 66MD***  | 66MU***   | ***   |   |
|                                   |    |   |                                    |    |   |
|                                    |    |   |                                     |    |   |
| Polycarbonate with soft grip touch knob, for dia. 6mm shaft with 4.6mm flat, clips clamping, without backlit         | Medium temperature knob, for 6mm dia shaft with 4.6 mm flat, clips clamping, inside recessed for bush mounting models, embossed arrow style | Medium temperature knob, for 6mm dia shaft with 4.6 mm flat, clips clamping, inside recessed for bush mounting models, printed skirt | Large diameter ABS knob, printable skirt style, for long dia. 6mm shaft with 4.6mm flat, clips clamping                 | Large diameter ABS flat printable knob for dia. 6.35mm shaft with 4.8mm flat, clips clamping, adjustable stop                             |   |

\*\*\* The complete reference is determined by other parameters such as plastic color, printing color, printing style etc.



# Setting of knobs with adjustable span

In some applications it may be necessary to limit the temperature maximum setting (or minimum) possible by the user. Some knobs that we have developed provide this option.

## Stainless steel stop for knob types 66MS and 66MZ

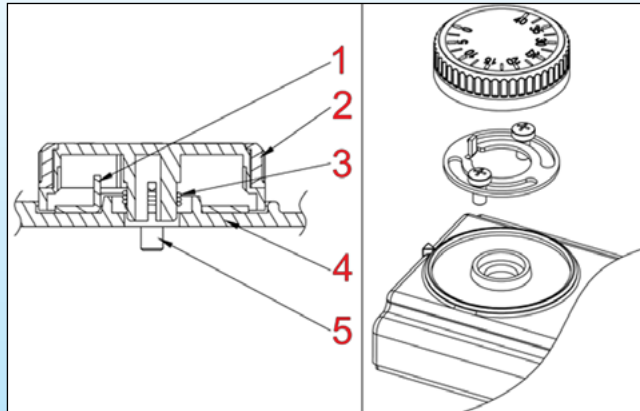





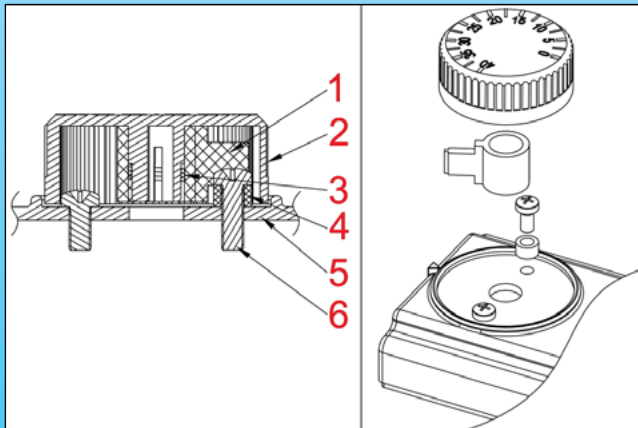

- 1: Adjustable stainless steel stop
- 2: Knob frame
- 3: Knob clips
- 4: Mounting wall
- 5: Thermostat mounting screws

|   |   |   |  |
|---|---|---|--|
|  |  |   |                 |
| Check the molded stop position on the backside of the knob                        | Take the adjustable cam 6YBUR001  | Put the adjustable cam under the thermostat mounting screws. It must be correctly centered. Tighten the 2 screws slightly | Adjust the cam position to the needed position, tighten the screws, and push the knob on the shaft |

## Plastic stop for knobs 66ME and 66MP



- 1: Adjustable plastic stop
- 2: Knob frame
- 3: Knob clips
- 4: Stop screw plastic spacer
- 5: Mounting wall
- 6: Thermostat mounting screws











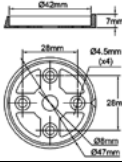

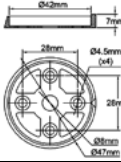

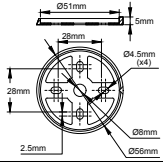

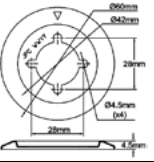

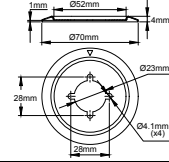

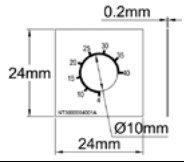

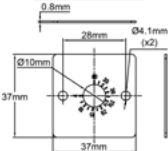
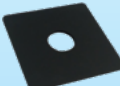
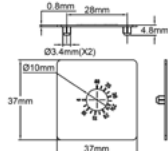
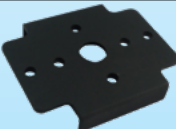
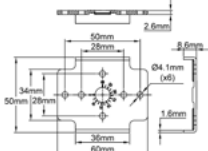

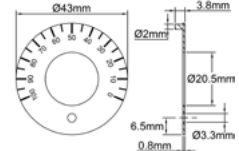

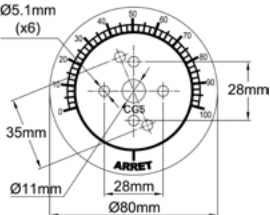
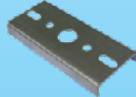
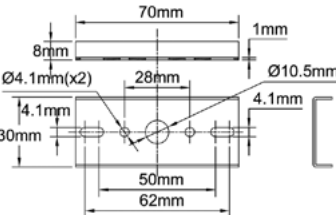
|  |   |   |  |  |   |
|--|---|---|--|--|---|
|  |  |  |  |   |  |
| Remove the span adjustment kit (plastic cam and washer) from inside the knob       | Split washer and cam  | Put the plastic washer under one of the M4 mounting screw heads                     | Put the cam again inside, at the requested angulation                                | Put the knob on the shaft, do not push the knob completely on the shaft, check if angulation is set correctly. Remove and set again if necessary | When set as needed, push the knob on the shaft  |

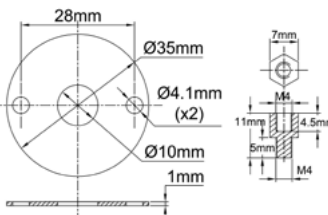
Because of permanent improvement of our products, drawings, descriptions, features used on these data sheets are for guidance only and can be modified without prior advice

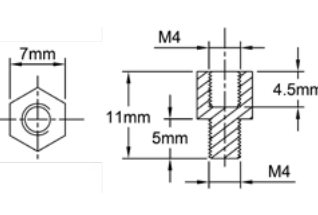
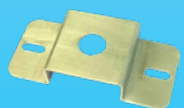
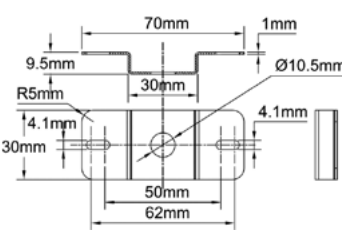

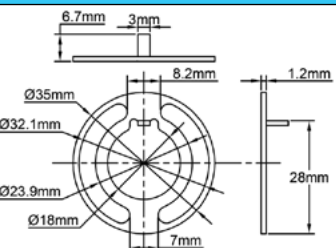
# Dials, bezels and mounting boards

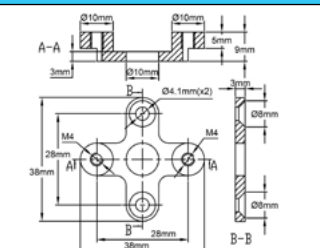
Because of permanent improvement of our products, drawings, descriptions, features used on these data sheets are for guidance only and can be modified without prior advice

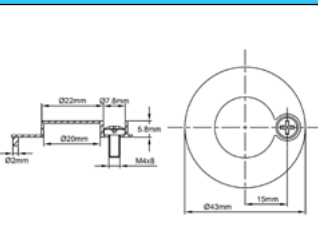
|  |   |  |  |   |   |
|--|---|--|--|---|---|
| <p>66EN1</p>   <p>Black ABS bezel for knobs dia. 40 to 41mm</p>  | <p>66EN3</p>   <p>Chrome plated ABS bezel for knobs dia. 40 to 41mm</p>   | <p>66EN4</p>   <p>Black ABS bezel for knobs dia. 50 to 51mm</p>  | <p>66EN2</p>   <p>Stamped stainless steel bezel for knobs dia. 40 to 41mm</p>  | <p>66EN5</p>   <p>Stainless steel bezel for knobs dia. 50 to 51mm</p> | <p>66CG12**</p>   <p>Printed adhesive PVC dial, for screw driver style shafts</p> |
| <p>66CP01</p>   <p>Black PBT plastic square printable dial, mounting with 2 M4 screws, 28mm distance. Adhesive version is also available</p> | <p>66CP02</p>   <p>Black PBT plastic square printable dial, push in mounting inside M4 threads, 28mm distance.</p>          | <p>66CP03****</p>   <p>Black PBT plastic counter-plate, printable, for screw driver or miniature knob adjustment</p>   | <p>66CP04****</p>   <p>Black PBT plastic square printable dial, round type, for S and V thermostat types</p>                             |   |   |
| <p>66CG5</p>   <p>Anodized aluminum dial for energy regulators</p>   | <p>66BR01</p>   <p>Inside bracket for internal screw driver adjustment, or waterproof shaft gasket, stainless steel</p> | <p>66BR02</p>   <p>Inside bracket for waterproof shaft gasket, stainless steel</p>   | <p>9BBVE300000048A</p>   <p>Extension screw for counter-plate with waterproof shaft gasket mounting</p>                              |   |   |
| <p>66BR03</p>   <p>Inside bracket for thermostat internal manual reset (Stainless steel)</p>  | <p>6YBUR001</p>   <p>Adjustable knob stop bracket (Fits 66MS and 66MZ knobs)</p>  | <p>66GA2890K</p>   <p>Bracket converter. Allows to rotate the thermostat bracket position of 90°. Can be used with every thermostat with 2 M4 screws 28mm distance</p> | <p>9BBZM1000210003A</p>   <p>Fixed setting cover. Avoid access to adjustment on S and V thermostat types. Replaces knob and dial</p> |   |   |

\*\* Full reference is defined by the printing.

# Waterproof wall feed-through for adjustment shafts



## Assembly examples with internal brackets

Screw driver adjustment thermostat, internal access manual reset thermostat

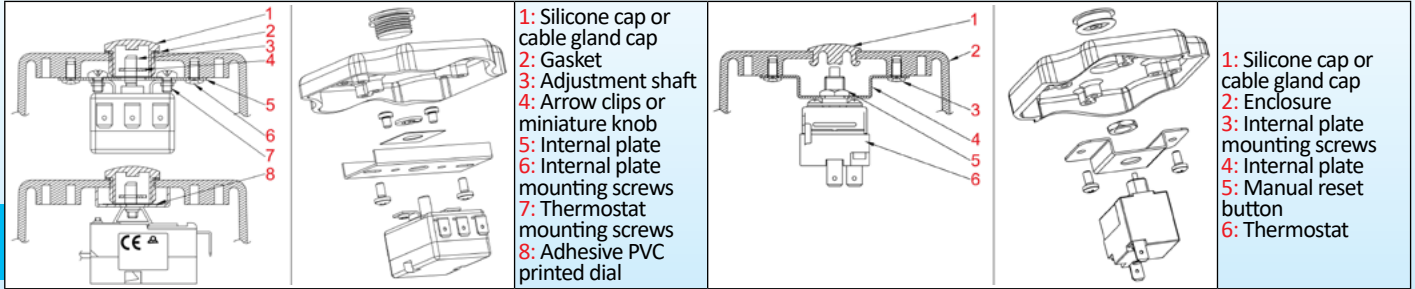

## Through wall waterproof gaskets for thermostat shafts

They allow mounting a thermostat or a switch through a wall, ensuring a good resistance against water ingress. The gasket, pressing on the shaft, is compressed between the enclosure wall and a counter-plate. A light lubrication of the counter-plate and the inner face of the wall is recommended.

**Flammability:** UL 94-V0

**Hardness:** 60 Shore A

**Color:** black. Other colors available (MOQ apply).

## Assembly examples with internal brackets

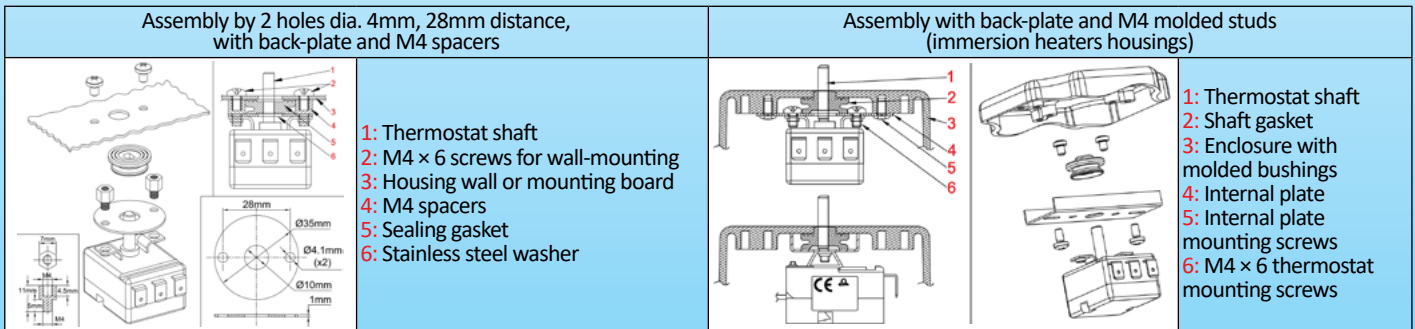

## Well feed-through gaskets



Because of permanent improvement of our products, drawings, descriptions, features used on these data sheets are for guidance only and can be modified without prior advice





# Pockets

| 66DR12510021C000            | 66DL14P****  | 66DI12****   | 66DK12****  | 66DU****  |
|-----------------------------|--|--|---|---|
|                             |  |  |   |   |
|                             |  |  |   |   |
| PBT pocket, 1/2" NPT thread | Nickel plated brass pocket, 1/4" BSPP thread. Available in various diameters and lengths | 304 Stainless steel pocket, with M4 securing screw, 1/2" BSPP thread. Available in various diameters and lengths | Nickel plated brass pocket, 1/2" BSPT thread Available in various diameters and lengths | Stainless steel mechanical protection for wall mounting thermostat bulb or sensor |

\*\*\*\* Many thermostat mounting accessories (pockets, flanges, fittings, coolers) have been developed for thermostats with enclosures, and can be used on thermostats for incorporation. See catalog No. 2 which gives all the possible references of these accessories.

## Pockets grommets

Used to hold probes or electronic thermostat bulbs inside a pocket or a tube, while protecting them against the sharp edges of the tip.

**Flammability:** UL 94-V0

**Hardness:** 60 Shore A

**Color:** black. Other colors available (MOQ apply)

| 9BBJ01000ELH095A   | 9BBJ01000SPH012A   | 9BBJ010000ELH024A                                       | 9BBJ0100004008A   | 9BBJ01000SPH002A   |
|--|--|---|---|--|
|  |  |   |   |  |
|  |  |   |   |  |
| Pocket grommet for 6.5mm ID and wire or capillary of 1.4mm | Pocket grommet for 7mm ID and wire or capillary of 2.3mm | Pocket grommet for 8 to 8.5mm ID and 4 x 2mm flat cable | Pocket grommet for 15mm ID and wire or capillary of 2.5mm | Pocket grommet for 16mm ID and 2 wires or capillary of 2.6mm and one cable of 6mm dia. |

Many silicone parts have been developed for thermostats with enclosures, and can be used on thermostats for incorporation. See catalog No. 2

## Flanges and fittings

| 66BF1  | 66BF3                                   | 66BF2                                   | 66RL41LB010   | 6YEBMG002                    |
|--|---|---|---|------------------------------|
|  |   |   |   |                              |
|  |   |   |   |                              |
| Air duct flange for rod thermostat with dia. 14.5mm output | Air duct thermostat flange for 6mm bulb | Air duct thermostat flange for 8mm bulb | Capillary stuffing box with flat gasket and M14 nut | Capillary grounding terminal |

## Rod coolers

| 66RF07015  | 66RF0231M12   | 66DA0008050400  |
|--|---|---|
|  |   |   |
|  |   |   |
| Rod cooler with 14.5mm termination. Used on high temperature rod thermostats. Fits the 3/8 thread located under the housing and the dia. 14.5 hole of pockets or flanges. Not usable on Y0 types | Rod cooler G1/2 Used on high temperature rod thermostats. Fits the 3/8 thread located under the housing and the 1/2 male thread of rod cooler bracket. Not usable on Y0 types | G1/2 Rod cooler bracket (for air ducts mounting) Not usable on Y0 types |



# Brackets, fittings and thermostat boots











## Thermostat boots

They are designed to protect thermostats against accidental contact or liquid ingress. They may, depending on the model, be filled with a resin or simply be glued or vulcanized on their support.

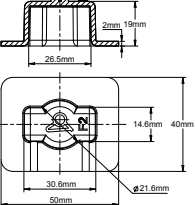
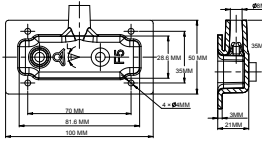
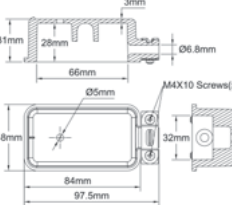
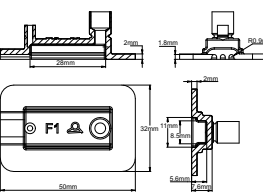
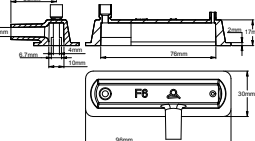
**Flammability:** UL 94-V0





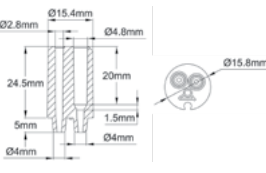
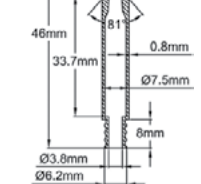
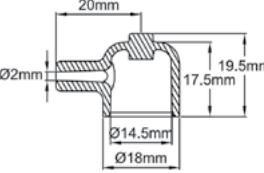
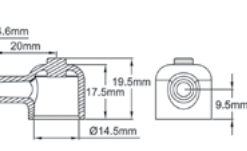
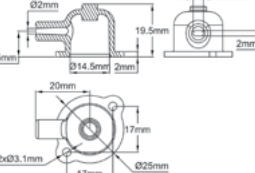





**Hardness:** 60 Shore A

**Color:** black or red depending on the model. Other colors are available. (MOQ apply).

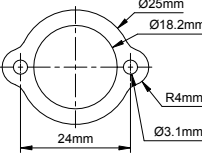
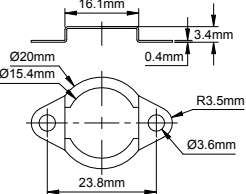
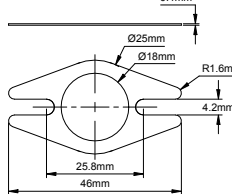
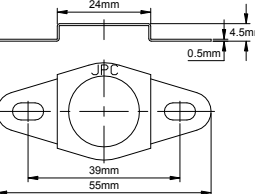
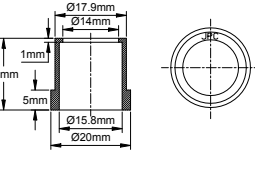
| 9BBJO1000SPH008A (F2)   | 9BBJO1000SPH006A (F5)  | 9BBS1515SPH020A  | 9BBJO1000SPH016A (F1)  | 9BBJO1000SPH018A (F6)   |
|---|--|--|--|---|
|    |   |     |                                   |    |
|    |   |     |                                    |    |
| Disc thermostat silicone boot, for flexible silicone heaters                        | Bimetal thermostat silicone boot, for flexible silicone heaters, with pilot light  | Bimetal thermostat silicone boot, for flexible silicone heaters, with cable retainer | Silicone boot for PT100, TCO or temperature limiters, with silicone RTV potting holes, for flexible silicone heaters | Silicone boot with cable retainer, for temperature limiters, with silicone RTV potting holes, for flexible silicone heaters |
| 9BBJO1000ELH025A  | 9BBJO1000ELH058A   | 9BBJO1000004015A   | 9BBJO1000004017A   | 9BBJO1000004019A  |
|    |   |     |                                   |    |
|   |  |    |                                   |   |
| Silicone grommet for thermal fuse and wires output, for cartridge heaters dia. 16mm | Silicone boot for TCO pocket mounting  | 1/2 disc thermostat protection boot, for flat wires 2.5 x 4.3mm to 3 x 4.8mm         | 1/2 disc thermostat protection boot, for dia. 5 to 8mm cable   | 1/2 disc thermostat protection boot, with securing bracket, for flat wires 2.5 x 4.3mm to 3 x 4.8mm                         |

Many disc thermostat protection boots have been developed for heat tracing applications, and can be used on thermostats for incorporations, see catalogue N°3.

## Brackets and accessories for disc thermostats

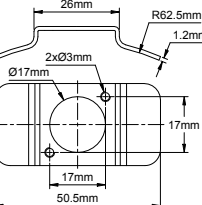
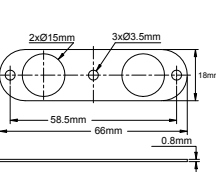
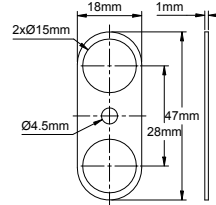
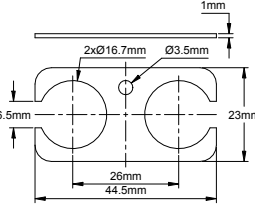
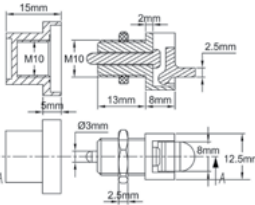
| 9BBAE1000000017A   | 9BBAE1000000018A  | 9BBAE1000000019A  | 9BBAE1000000011C   | 9BBBT1000000006A   |
|--|---|---|--|--|
|   |  |  |                                 |                         |
|   |  |  |                                  |                         |
| Stainless steel bracket for silicone cap 9BBJO3000004019A  | Stainless steel extended mobile bracket for 1/2 disc thermostat.                    | Large flat bracket, stainless steel, for 1/2 disc thermostat.                       | Large stainless steel extended mobile bracket for 1/2 disc thermostat with boot 9BBBT1000000006A                     | Black polypropylene boot for epoxy potting on 1/2 disc thermostat. Can be used with bracket 9BBAE1000000011C |
| 9BBBT1M00ELH025D   | 9BBAE1000000040A  | 9BBAE1000000015A  | 9BBAE1000000041A   | 6Y4903RESET90  |
|   |  |  |                                 |                         |
|   |  |  |                                  |                         |
| 1/2 extended cup disc thermostat mounting bracket for pipe or tank mounting. Stainless steel. Must be spot welded on pipe. Specify pipe dia. | Two 1/2 disc thermostat mounting bracket, 3 screws, stainless steel                 | Two 1/2 disc thermostat mounting bracket, center screw, stainless steel             | Two 1/2 disc thermostat mounting bracket, center screw, stainless steel, open type for thermostats with QC terminals | Side manual reset button. This component allows to reset an 1/2 disc thermostat from the side                |

Because of permanent improvement of our products, drawings, descriptions, features used on these data sheets are for guidance only and can be modified without prior advice



# Shaft switches

## Additional thermostat shaft rotary switch, 20A 250-400V

### Type LS

#### Dimensions

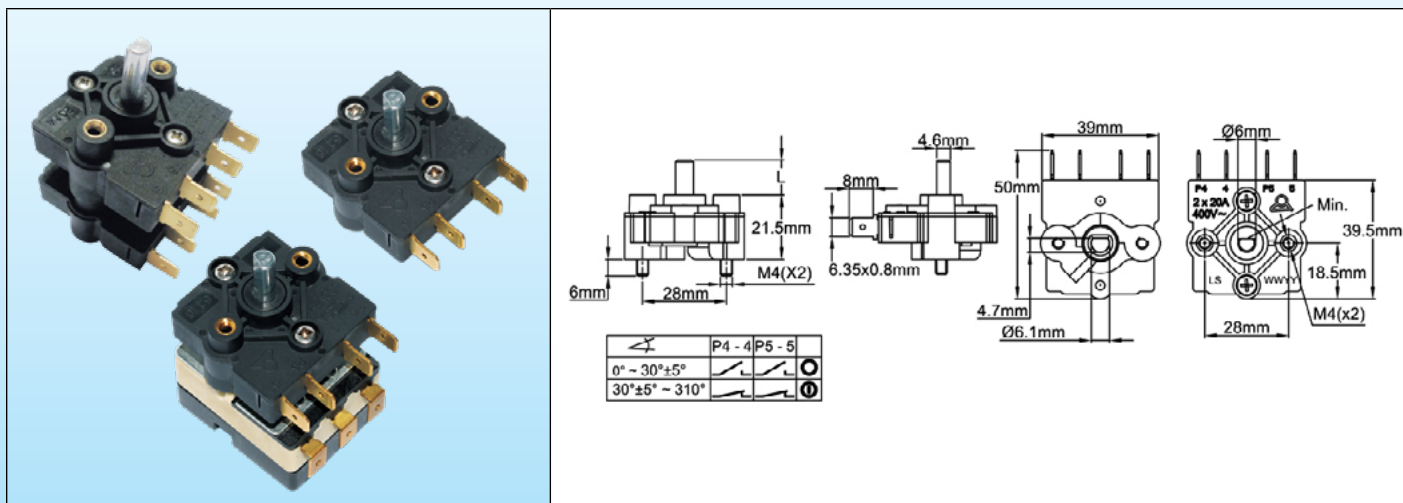

#### Applications

These on-off switches are designed to be added on thermostat shafts. They provide off position when the thermostat shaft is at the minimum position. They are available in single pole contact, two pole (one level) and three pole or four pole contacts (two levels).

#### Main features

**Installation:** on thermostats with 6mm shaft and 4.6mm flat, mounting by two M4 screws 28mm distance. Shaft length of thermostat that receives this switch must be 12mm maximum.

**Shaft lengths available:** 11.5; 15; 23mm

**Shafts:** Galvanized steel

**Operation diagram:** the contacts are open between 0° and 30 +/ -5° angular and closed between this value and 310°.

**Electrical rating:** 20A 250/ 400V res., 6000 cycles

**Rotation:** can be used on thermostats with 180 to 310° angular shaft rotation

**Contact clearance:** between 0 and 20° angle, the contact spacing is greater than 3mm.

**Temperature:** 85°C

**Case Material:** PA66, UL94 VO

**Connection:** 6.35 × 0.8 tabs. Screw terminals available (MOQ).

**Options:** change of flat position, different contact opening or closing positions.

#### Main references with shaft length L=11.5mm

| Level quantities | Switch quantities | References       |
|------------------|-------------------|------------------|
| 1                | 1                 | LS12190259025160 |
| 1                | 2                 | LS12290259025160 |
| 2                | 3                 | LS12390259025160 |
| 2                | 4                 | LS12490259025160 |

\* Screw terminals option: replace 60 by V0 on the last 2 numbers in the product reference.

Because of permanent improvement of our products, drawings, descriptions, features used on these data sheets are for guidance only and can be modified without prior advice

# Connector for thermostat terminals



## Dimensions

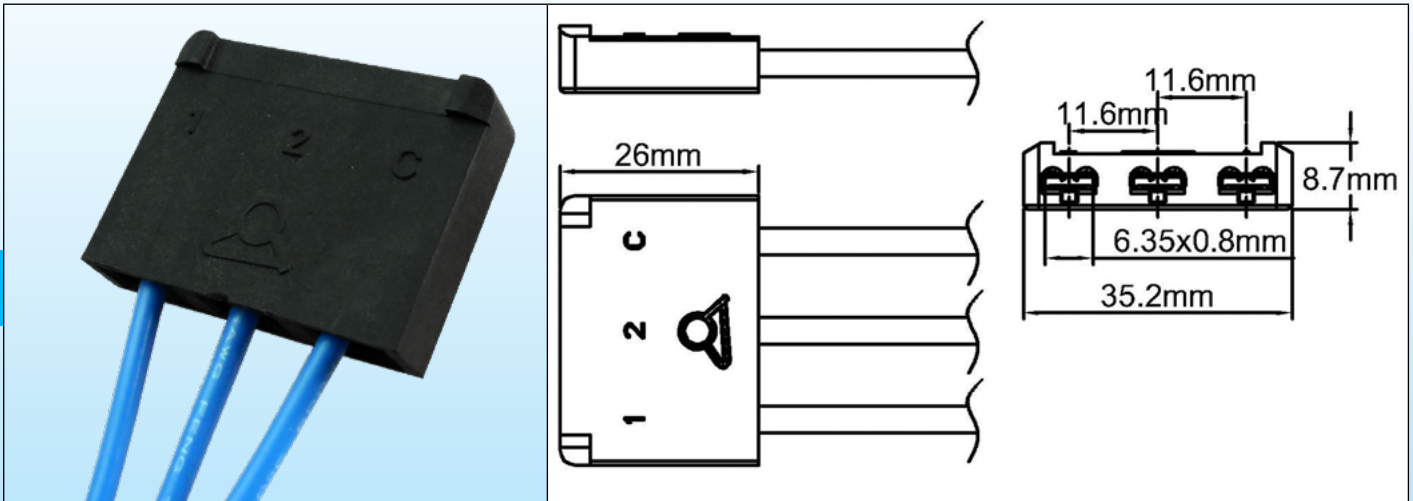

**Application:** Faster thermostat wiring, and elimination of wiring mistake, (foolproof design)

**Compatibility:** Connector for bulb and capillary for thermostat types 8G (with straight or 90° bended terminals), and all models of types KO, KP and KZ.

**Number of terminals:** 3, compatible with 6.3 × 0.8 tabs

**Material:** Fiberglass reinforced PA66

**Options :**

- Unassembled, with female terminals non-crimped,
- Assembled, with crimped wires, length, gauge and style upon customer request.

| Reference | 66KG3635* |
|-----------|-----------|
|-----------|-----------|

\* The 16 character full reference is issued upon customer wire types and length specs



Because of permanent improvement of our products, drawings, descriptions, features used on these data sheets are for guidance only and can be modified without prior advice





Because of permanent improvement of our products, drawings, descriptions, features used on these data sheets are for guidance only and can be modified without prior advice





# ULTIMHEAT

## HEAT & CONTROLS



Catalogues collection on  
[www.ultimheat.com](http://www.ultimheat.com)

**Electromechanical components & OEM heating sub-assemblies manufacturer**

- Mechanical thermostats
- Mechanical safeties single & three poles
- ATEX thermostats & safeties
- Flow through liquid heaters
- Immersion heaters
- Heating elements for air and liquid
- Connection blocks
- Housings for corrosive environments
- Flow switches
- Level switches
- Pressure switches and air switches
- Fusible links and fire detection mechanisms
- Tracing equipment
- **Taylor made solutions**



# OF THE EFFECTS OF THE RECENT REVISIONS OF THE

## ARTICLE 101 AND 102 OF THE TREATY ON THE FUNCTIONING OF THE EUROPEAN UNION

### IN THE LIGHT OF THE CASE-LAW OF THE COURT OF JUSTICE OF THE EUROPEAN UNION

#### BY

DR. J. M. M. VAN DER WOUDE

ASSISTANT PROFESSOR OF LAW, UNIVERSITY OF ROTTERDAM

AND

DR. M. J. M. VAN DER WOUDE

ASSISTANT PROFESSOR OF LAW, UNIVERSITY OF ROTTERDAM

AND

DR. M. J. M. VAN DER WOUDE